

CONSTRUIRE TOUT de A à Z



jusqu'au 24 décembre 2019



SOMAC

MATÉRIAUX DE CONSTRUCTION

PAPEETE
Vallée de Titiroa
Tél. : 40 501 950
Fax : 40 426 037
somac@somac.pf

RAIATEA
Z.I. de Tahina
Uturoa
Tél. : 40 600 600
Fax : 40 662 626
contact@somacraiatea.pf

OFFRE SPÉCIAL

GROS TRAVAUX

Bétonnière GNT350 Guy NOEL

Moteur HONDA GX160
essence, 5,5 cv,
2 sacs de 35 kg

Réf. ALT0010



1



2



3



4

OFFERT

1 - Brouette roue increvable, Caisse galva - Réf. ALT0014 • 2 - Taloche, noir, manche en bois - Réf. SOM0901
3 - Seau plastique, TALIAPLAST, 11 L - Réf. TAL0037 • 4 - Pelle US, manche en bois - Réf. SOMJ100

L'ENSEMBLE

284 995 F

Réf. lot ALT0015





GROS œuvre

Armature.....	4
Parpaing, Béton cellulaire.....	6
Étanchéité, Adjuvant.....	8
Bétonnière.....	12
Manutention, Levage.....	14
Echafaudage.....	18
Protection.....	22
Outillage d'atelier.....	26
Soudure, Accessoire.....	28
Outillage électroportatif.....	32
Acier, Tôles.....	38
Charpente.....	44
Toiture.....	48



SECOND œuvre

Panneaux fibrociment, Lambris.....	50
Panneaux bois et moulures.....	52
Cloison.....	56
Isolation.....	58
Electricité.....	60
WC.....	62
Lave main, Vasque.....	64
Receveur, Parois de douche.....	70
Hydrothérapie, Miroir.....	76
Revêtement de sol.....	86
Peinture.....	106
Porte bois, Porte technique.....	108
Baie vitrée aluminium.....	136
Jardin.....	140





ARMATURE

FONDATION

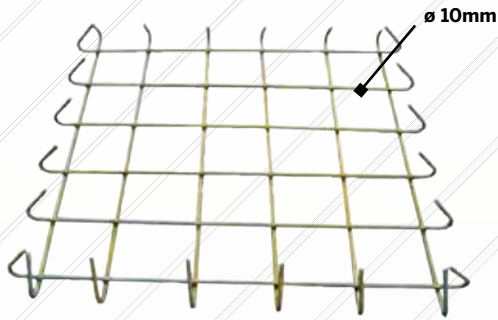

SEMELLE ISOLÉE

Dimensions en cm.	Réf.	PRIX
40 x 40	KAAFS10	875 F
50 x 50	KAAFS11	1 025 F
60 x 60	KAAFS12	1 565 F
70 x 70	KAAFS13	1 770 F
80 x 80	KAAFS14	2 475 F
90 x 90	KAAFS15	2 590 F
100 x 100	KAAFS16	3 480 F

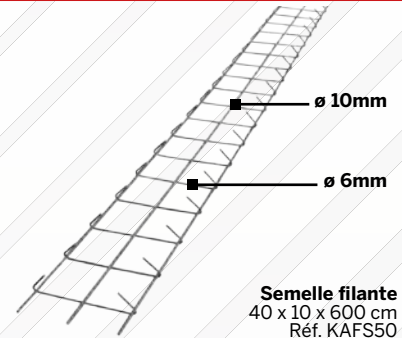

Semelle filante
40 x 10 x 600 cm
Réf. KAFS50

5 990 F

ARMATURE ASSEMBLÉE



Attente poteau
9 x 9 x 170 cm
Réf. KAFAP10

2 990 F

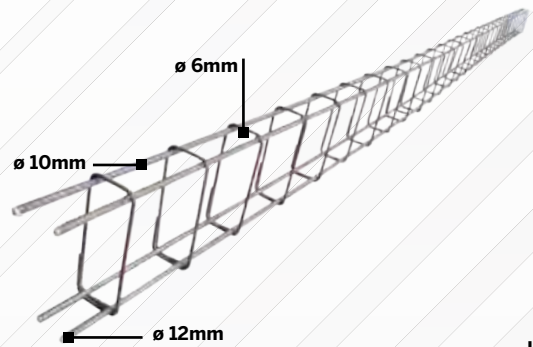

Longrine
9 x 23 x 600 cm
Réf. KAFL30

9 205 F

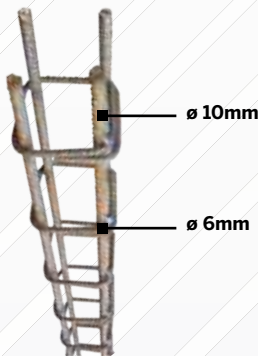

Poteau
9 x 9 x 300 cm
Réf. KAFAP20

3 935 F

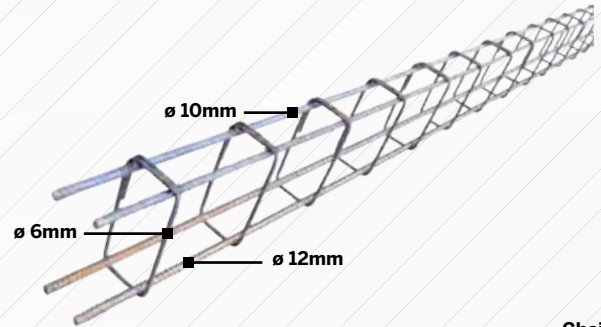

Chainage
9 x 19 x 600 cm
Réf. KAFC20

8 895 F

ARMATURE FAÇONNÉE



Étrier façonné
Fil ø 6mm

Dimensions en cm	Réf.	PRIX
9 x 9	KACD099	50 F
9 x 19	KACD199	65 F
9 x 23	KACD239	75 F

ARMATURES PRÉFABRIQUÉES BÉTON PRÊT À L'EMPLOI



uniquement sur Tahiti



Tél. : 40 50 19 50 - Fax : 40 42 60 37

PANNEAU DE DALLAGE



Désignation	Dimensions en m	ø fil en mm	Maille en mm	Réf.	PRIX
PAFC	3,60 x 2,40	4,5	200 x 200	BSO80C	2 775 F
PAF10	4,20 x 2,40	5,5	200 x 200	BST11	4 914 F
ST20	6,00 x 2,40	6	150 x 300	BST20	8 837 F
ST25	6,00 x 2,40	7	150 x 300	BST25	10 350 F
ST25C	6,00 x 2,40	7	150 x 150	BST25C	13 245 F
ST35	6,00 x 2,40	7	100 x 300	BST35	14 457 F
ST50	6,00 x 2,40	8	100 x 300	BST50	16 749 F
ST50C	6,00 x 2,40	8	100 x 100	BST50C	24 570 F
ST60	6,00 x 2,40	9	100 x 200	BST60	22 985 F
ST65C	6,00 x 2,40	9	100 x 100	BST65C	34 360 F

ROND CRÉNELÉ

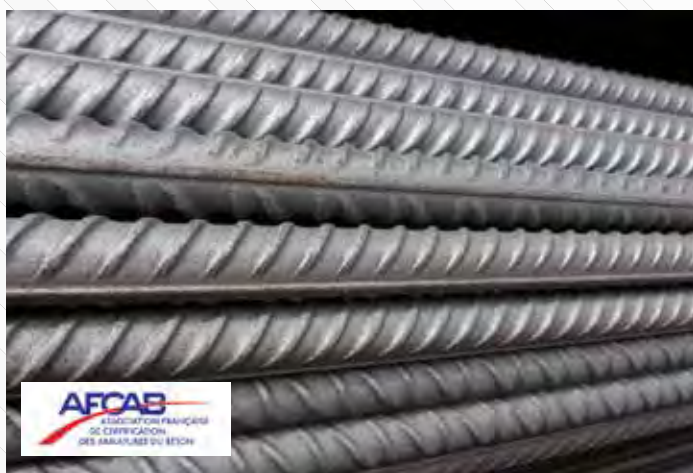

Longueur 6 m			Longueur 12 m		
ø en mm	Réf.	PRIX	ø en mm	Réf.	PRIX
6	BRC0661	220 F	-	-	-
8	BRC0861	333 F	8	BRC0812	666 F
10	BRC1061	520 F	10	BRC1012	1 039 F
12	BRC1261	748 F	12	BRC1212	1 496 F
14	BRC1461	1 043 F	14	BRC1412	2 085 F
16	BRC1661	1 362 F	16	BRC1612	2 724 F
20	BRC2061	2 164 F	20	BRC2012	4 327 F
25	BRC2506	3 380 F	25	BRC2512	6 760 F
32	BRC3261	5 448 F	32	BRC3212	10 897 F
-	-	-	40	BRC4012	15 104 F

ROND LISSE



Longueur 6 m		
ø en mm	Réf.	PRIX
8	BRL08	370 F
10	BRL10	640 F
12	BRL12	900 F
14	BRL14	1 108 F
16	BRL16	1 566 F
20	BRL20	2 230 F

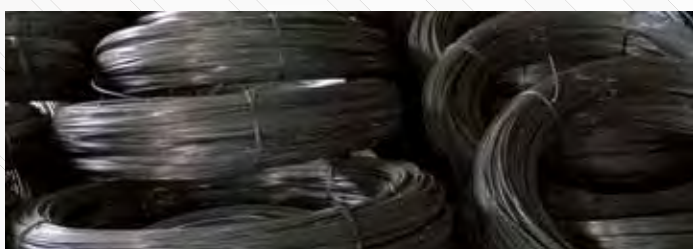

Rouleau fil attache noir
ø 1,1 mm - 5 kg - Réf. LEV3022

1 995 F

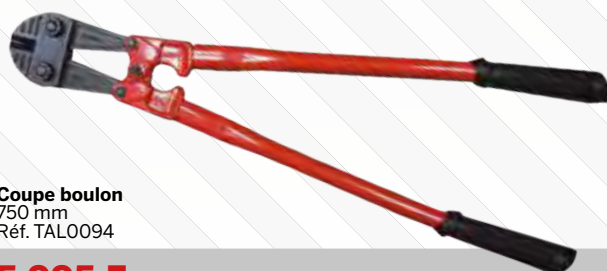

Coupe boulon
750 mm
Réf. TAL0094

5 995 F

TREILLIS SOUDÉ

FER À BÉTON



PARPAING - Tarifs des parpaings applicables à Tahiti



Parpaings / Épaisseur 10 cm		
Dimensions en cm	Réf.	PRIX
20 x 50	PAR10	205 F
25 x 50	PA10	230 F

Parpaings / Épaisseur 15 cm		
Dimensions en cm	Réf.	PRIX
20 x 50	PAR15	275 F
25 x 50	PA15	299 F



Parpaing bouché
20 x 20 x 50 cm
Réf. PA20

310 F



Parpaing banché
20 x 20 x 50 cm
Réf. PA21

316 F



Parpaing pilotis
26 x 26 x 25 cm
Réf. PA22

545 F

MATÉRIEL



Serre-joint de maçon
400 x 600 - Réf. SOM0106
600 x 800 - Réf. SOM0107 - **1 195 F**
800 x 1000 - Réf. SOM0108 - **1 295 F**
1000 x 1200 - Réf. SOM0109 - **1 495 F**

à partir de 995 F



Mortier réfractaire 156
PAREXLANKO
Sac de 25 kg
Réf. LAN5105

7 295 F



Treuelle italienne ronde
22 cm
Réf. FMON256

710 F



Taloche rectangle
Noire
42 x 28 cm
Réf. SOM0901

495 F



Brique réfractaire
220 x 110 x 60 mm
Réf. AQ070

875 F

Résiste jusqu'à 1 100°C

CLOISON À MATÉRIEAUX HUMIDES



BÉTON CELLULAIRE



Carreaux béton cellulaire 60 x 50 cm		
Épaisseur en cm	Réf.	PRIX
5	BET0001	1 195 F
7,5	BET0002	1 480 F
10	BET0003	1 980 F

Béton cellulaire
60 x 25 x 15 cm
Réf. BET0010

1 565 F

CLOISON À MATÉRIAUX HUMIDES

ACCESSOIRE



Mortier colle 561 PAREXLANKO
5 kg - Réf. LAN5109
25 kg - Réf. LAN5110 - **4 395 F**

À partir de 1 695 F



Truelle à colle
10 cm
Réf. TAL0030

1 995 F



Scie égoïne pour béton cellulaire
650 mm
Réf. FSTA410

5 995 F



Scie pour béton cellulaire DWE 396-QS DEWALT
295 mm - 1 600w
Réf. DEW0605

58 995 F



Scie pour béton cellulaire DWE 397 DEWALT
450 mm - 1 700w
Réf. DEW0602

72 995 F



Résine scellement chimique polyvalent
Ton pierre
300 ml
Réf. SCL0060

995 F



ÉTANCHEITÉ

GÉOTEXTILE



PROFESSIONNEL

Vendu au mètre linéaire					
Modèle	Largeur	Épaisseur mm		Réf.	PRIX
F200M	2,5 m	2		FIB022	690 F



Vendu au rouleau					
Modèle	Dimension	Épaisseur mm	Surface m ²	Réf.	PRIX
F22	1 x 25 m	0,7	25	FIB040	5 395 F
F31	2 x 100	0,8	200	FIB025	42 283 F
	3 x 100		300	FIB026	63 226 F
	5 x 100		500	FIB027	99 995 F
F55	5 x 100	1,6	500	FIB029	180 995 F
F650	5,5 x 50	5	275	FIB028	190 995 F



DRAINAGE



FILTRATION



PROTECTION



SÉPARATION



RENFORCER



PARTICULIER

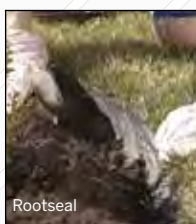

Rootseal



Weedseal



Multigéo

Modèle	Dimension	Surface m ²	Réf.	PRIX
Rootseal	1 x 5 m	5	FIB034	6 995 F
Weedseal	1 x 25 m	25	FIB036	7 295 F
Multigéo	1 x 25 m	25	FIB030	6 295 F
	2 x 25 m	50	FIB031	9 995 F



POLYANE

POLYANE

Film polyane multi usages
Protection
Largeur 6 mètres
épaisseur 55 microns
Réf. WPMULTJ

175 F m./linéaire



Film polyane noir
Épaisseur 150 microns - Largeur 6 mètres
Réf. WPPOLY

580 F m./linéaire



Film transparent
Épaisseur 200 microns - Largeur 6 mètres
Réf. WPPOLY3

1 195 F m./linéaire



PARTIE ENTERRÉE

10 m²
environ

**Dry plus
WEBER**
Mortier
d'imperméabilisation
Sac 25 kg
Réf. WEB0101



4 995 F

6 m²
environ

Mariseal
Résine
bi-composant
polynéthane
Seau 10 kg
Réf. MAR0030



19 995 F

50 m²
environ

Lakoblack fluid 212
Vernis bitumineux
Pot 25 L
Réf. LAN1101



25 895 F

12 m²
environ

**Lakoblack
pateux 201**
Enduit
bitumineux
Seau 25 Kg
Réf. LAN1102



13 890 F



ÉTANCHEITÉ TOITURE



Silatex super pro
Peinture d'étanchéité
Blanc
Seau 5 kg - Réf. MAR0010
Seau 12 kg - Réf. MAR0012 - **8 995 F**

1 m²/ kg
environ

À partir de 3 995 F



Sikalastic
Peinture d'étanchéité
Blanc
Seau 20 kg - Réf. SIKA011 - **17 790 F**

0,8 m²/ kg
environ

À partir de 5 380 F



ÉTANCHEITÉ

ADJUVANT BÉTON

Sikalite
Hydrofuge
de masse
sachet 1 kg
Réf. SIKA005



355 F

323 Lankofuge
Hydrofuge
de masse
sachet 250 g
Réf. LAN0105



795 F

Chrysofuge B4
Hydrofuge de masse
Fût 60 L - Réf. CHRY014
Fût 215 L - Réf. CHRY017 - **55 295 F**



À partir de 23 295 F

+ ADJUVANTS



COLORANT POUR BETON

	Couleur	Poids	Réf.	PRIX
	Ocre C960	20 kg	CHRY056	11 990 F
	Rouge 130	25 kg	CHRY060	12 490 F
	Noir 318	25 kg	CHRY058	13 495 F
	Brun 686	25 kg	CHRY051	18 290 F
	Brun 610	25 kg	CHRY052	19 995 F
	Jaune C415	20 kg	CHRY054	22 995 F
	Vert	25 kg	CHRY062	58 595 F

Disponible en sachet de 1 kg

PLASTIFIANT / FLUDIFIANT



**751 lankolatex
PAREXLANKO**
2 L - Réf. LAN0113
5 L - Réf. LAN0114
5 995 F
20 L - Réf. LAN0115
23 995 F

à partir de **2 995 F**



**314 lankofluid
PAREXLANKO**
Sachet 350 ml
Réf. LAN0102
Fût 20 L - Réf. LAN0103
20 495 F

à partir de **890 F**



**Optima 206
CHRYSO**
Fût 20 L - Réf. CHRY006
Fût 215 L - Réf. CHRY007 - **103 495 F**
Cuve 1 000 L - Réf. CHRY008 - **437 195 F**

à partir de **32 690 F**

ADJUVANTS BÉTON

DÉMOULAGE



**Dem elio
CHRYSO**
Bidon 60 L - Réf. CHRY039
Fût 215 L - Réf. CHRY038 - **77 990 F**

à partir de **26 190 F**

RETARDATEUR



**Chrysotar CHR
CHRYSO**
Retardateur de prise
Fût 215 L - Réf. CHRY0010
Cuve 1 000 L - Réf. CHRY011 - **215 595 F**

à partir de **52 195 F**

ACCÉLÉRATEUR



**301 accélérateur
PAREXLANKO**
Sachet 350 g
Réf. LAN0101

995 F

FIBRE À BÉTON



**360 Lanko fibre
PAREXLANKO**
Sachet 100 g
Réf. LAN0112

695 F



**Chryso fibre
CHRYSO**
Sachet 600 g - Réf. CHRY001
Sachet 910 g - Réf. CHRY002 - **1 390 F**

à partir de **995 F**

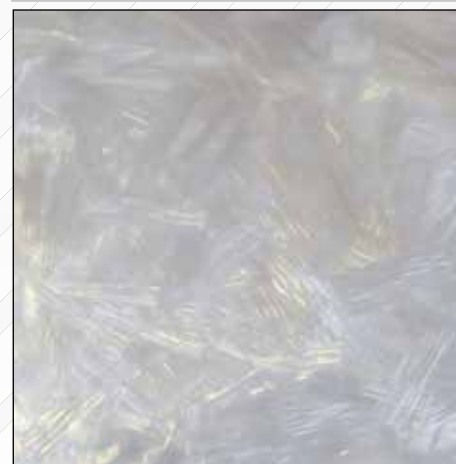



RÉPARATION

165 Proliprim universel
PAREXLANKO
 2 L - Réf. LAN4112
 5 L - Réf. LAN4113
10 990 F
 20 L - Réf. LAN4115
38 490 F



Fibré

Mortier de réparation
PAREXLANKO
 5 kg - Réf. LAN6001
 10 kg - Réf. LAN6002 - **3 995 F**



à partir de **5 995 F**

à partir de **2 790 F**

RÉAGRÉAGE MUR

ÉPAISSEUR EN MM
 Int/Ext **3-4**
<0,8
 kg/m²/mm



101 parenduit
PAREXLANKO
 Seau 20 kg - Réf. LAN4101
 Fût 150 kg - Réf. LAN4102 - **24 990 F**

à partir de **3 995 F**

ÉPAISSEUR EN MM
 Int/Ext **5-10**
<1,5
 kg/m²/mm



113 ertomur
PAREXLANKO
 Sac de 25 kg
 Réf. LAN4103

2 290 F

RÉAGRÉAGE SOL

ÉPAISSEUR EN MM
 Int/Ext **7-20**
<1,9
 kg/m²/mm
 AUTO NIVELLANT



123 lankosol épais
PAREXLANKO
 Sac de 25 kg
 Réf. LAN4104

6 295 F

ÉPAISSEUR EN MM
 Int/Ext **1-10**
<1,4
 kg/m²/mm



Mur fin
WERBER
 Sac de 25 kg
 Réf. WEB0001

2 290 F

ÉPAISSEUR EN MM
 Int/Ext **1-10**
<1,5
 kg/m²/mm



Repoplan
WERBER
 Sac de 25 kg
 Réf. WEB0002

1 995 F

ÉPAISSEUR EN MM
 Int/Ext **3-10**
<1,9
 kg/m²/mm
 AUTO NIVELLANT



133 lankosol
PAREXLANKO
 Sac de 25 kg
 Réf. LAN4107

5 595 F

PRÊT À L'EMPLOI

AGRÉGAT
 Int/Ext **<4**



Mortier multi-travaux
PRB
 Sac de 5 kg
 Réf. PRB0032

1 195 F

AGRÉGAT
 Int/Ext **<4**



151 mortier universel
PAREXLANKO
 Sac de 25 kg
 Réf. LAN5102

2 495 F

AGRÉGAT
 Int/Ext **<10**



154 béton universel
PAREXLANKO
 Sac de 25 kg
 Réf. LAN5103

1 995 F



OUTILLAGE DE CHANTIER

PARTICULIER



Bétonnière BX132
Guy NOEL
700 W - 1/2 sac de 35 kg
Réf. ALT0001

42 995 F



Bétonnière BX163 Guy NOEL
700W - 3/4 sac de 35 kg
Réf. ALT0007

46 995 F



ARTISAN



Bétonnière BX181
Guy NOEL
850W - 1 sac de 35 kg
Réf. ALT0042

58 995 F



Bétonnière GN130 Guy NOEL
1/2 sac de 35 kg
Réf. ALT0046

44 995 F



Bétonnière GN150 Guy NOEL
1/2 sac de 35 kg
Réf. ALT0047

46 995 F



Bétonnière GN165
Guy NOEL
850 W - 3/4 sac de 35 kg
Réf. ALT0008

49 995 F



**SANS
DÉMULTIPLICATEUR**

Bétonnière GN180 Guy NOEL
1 sac de 35 kg
Réf. ALT0045

56 995 F



**AVEC
DÉMULTIPLICATEUR**

Bétonnière GN180 Guy NOEL
1 sac de 35 kg
Réf. ALT0009

57 995 F



Plaque vibrante
ALTRAD BELLE
Moteur Honda GX100
4 temps - PCX13/40 - Réf. ALT3002

256 990 F



Scie sol 450
GUARDIAN
Moteur HONDA GX390
Découpe de 125 à 185 mm
Réf. ALT3006

484 995 F

BÉTONNIÈRE ÉLECTRIQUE

PROFESSIONNEL



Bétonnière GN180 Guy NOEL
Moteur Kohler 2,4 cv - 1 sac
Réf. ALT0006

119 995 F



Bétonnière Minimix 150 Guy NOEL
Moteur Honda GX120
Essence - 4 cv - 1/2 sac de 35 kg
Réf. ALT0036

123 995 F



Bétonnière GNT230 Guy NOEL
Moteur Honda GX160 essence - 5,5 cv
1 sac de 35 kg - Réf. ALT0043

269 995 F



Bétonnière GNT350 Guy NOEL
Moteur Honda GX160 essence - 5,5 cv
2 sacs de 35 kg - Réf. ALT0010

284 995 F



Bétonnière GNT430 Guy NOEL
Moteur Honda GX160 - Essence - 5,5cv
2 sacs de 35 kg - Réf. ALT0011

314 990 F



**TRANSMISSION
À CHAÎNE**

Bétonnière thermique GX160UX
Guy NOEL
Moteur Honda - Essence - Transmission à chaîne
2 sacs de 35 kg - Réf. ALT0044

395 995 F

**BÉTON PRÊT À L'EMPLOI
ARMATURES PRÉFABRIQUÉES**

uniquement sur Tahiti

SOMAB
BÉTON PRÊT À L'EMPLOI - ARMATURES PRÉFABRIQUÉES

Tél. : 40 50 19 50 - Fax : 40 42 60 37

BÉTONNIÈRE THERMIQUE



SIGNALISATION

FILET DE SIGNALISATION

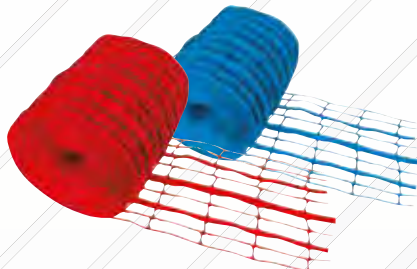

Filet avertisseur 30 cm x 100 m
Eau - Bleu - Réf. SOM0811
Electricité - Rouge - Réf. SOM0812

2 720 F

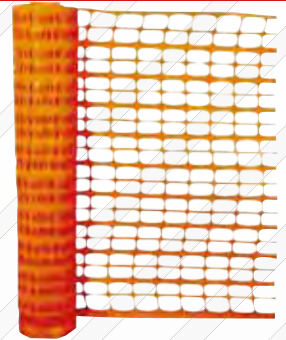

Filet de chantier 100 cm x 50 m
Orange
Réf. SOM0810

4 995 F

BALISAGE DE CHANTIER

SIGNALISATION



Barrière rouge et blanc 100 x 150 cm
Réf. ALT4002

4 995 F



Barrière de chantier galva 100 x 198 cm
Réf. SOM0520

7 995 F



Panneau de chantier « chantier interdit au public »
80 x 40 cm

Réf. TAL1407

1 395 F



Ruban de balisage Rouge et blanc 50 mm x 100 cm
Réf. TAL1011

495 F



Chevalet de chantier « travaux en cours »
Hauteur 62 cm
Réf. TAL1581

4 590 F



Traceur de chantier 500 ml
plusieurs coloris disponible
Réf. TAL0753 à TAL0758

à partir de 1 295 F

RALENTISSEUR

RALENTISSEUR

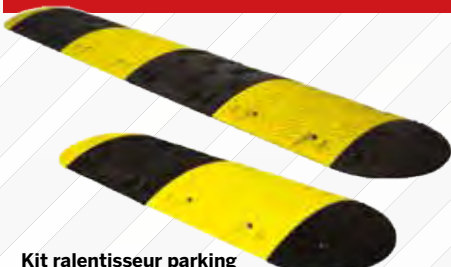

Kit ralentisseur parking
Hauteur 6 cm - largeur 43 cm
4 modules - Long. 1,43 m - Réf. NOV3001
6 modules - Long. 2,43 m
Réf. NOV3002 - **42 495 F**

À partir de 25 595 F





MANUTENTION



Palan à chaîne
FARTOOLS
Charge max. 2 tonnes
hauteur max. 2,5 m
Réf. FAR0136

11 990 F



Palan électrique
FARTOOLS
Charge max. 400 kg
Réf. FAR0131

27 995 F



Lève plaque placo
TALIATOP
Hauteur max. : 3,30 m
hauteur mini : 1,55 m
Charge max. 65 kg
Réf. TALI603

86 995 F



MANUTENTION

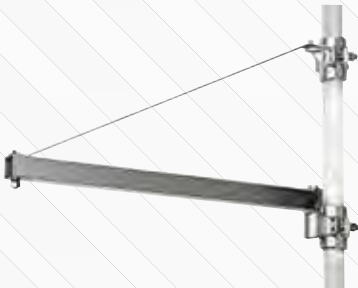

Support pour palan
FARTOOLS
Amovible à 180°
Longueur du bras 75 à 110 cm
Réf. FAR0132

7 995 F



Sangle d'attache à cliquet
Bleue - 5 cm x 9 m
Réf. OLC0009

3 195 F



Chariot
250 kg max.
1 plateau - Réf. AGE3052
2 plateaux - Réf. AGE3053 - **48 990 F**

À partir de 39 990 F

OUTILLAGE D'ATELIER



Cric à bouteille
4 tonnes max.
Réf. AGE4019

4 995 F



Cric à pédale
3 tonnes max.
Réf. AGE4020

39 995 F

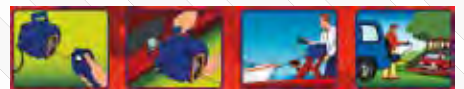

Treuil de traction
12 V - 5 tonnes tractable max. - Réf. AGE3017

52 995 F



MANUTENTION

BROUETTE ESPACE VERT

PARTICULIERS



Brouette Eco
Roue pleine - Réf. SOMJ202

65 L

5 395 F

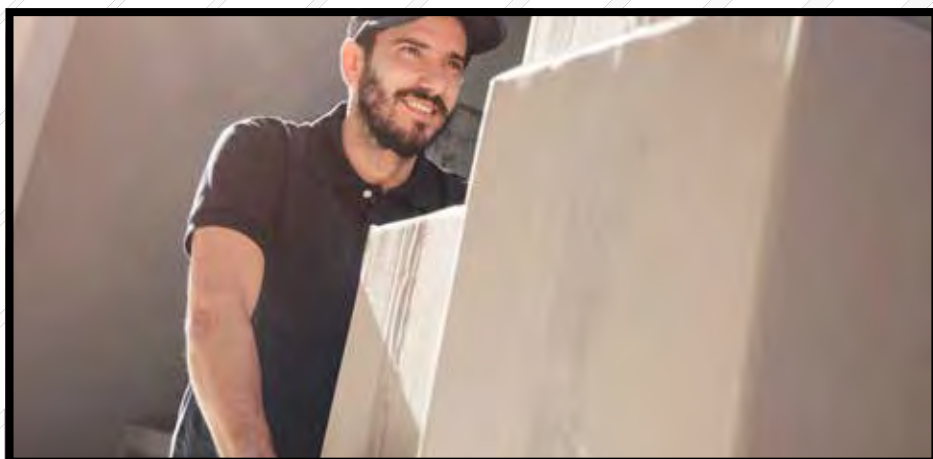

Brouette orange
Roue gonflée - Charge maxi 130 Kg
Réf. BRO1007

65 L

5 995 F



Brouette jaune
Roue pleine - Charge maxi 130 Kg
Réf. BRO1006

65 L

6 995 F



Brouette Cargo Pick up
Roue gonflée - Caisse jaune
Charge utile 160 Kg
Réf. HAE0102

110 L

9 995 F

PROFESSIONNELS

BROUETTE CHANTIER



Brouette Cargo Prems
Roue pleine - Charge utile 100 kg
Réf. HAE0050

90 L

5 995 F



Brouette Export peinte
Roue pleine - Réf. ALT0012

100 L

6 995 F



Brouette roue increvable
Caisse galva - Réf. ALT0014

100 L

8 795 F



Brouette Cargo Médium peinte
Roue pleine - Charge utile 150 kg
Réf. BRO2002

100 L

6 995 F



Brouette Cargo Médium galva
Roue pleine - Charge utile 150 kg
Réf. BRO2003

100 L

6 995 F



Brouette Cargo Reno
Roue pleine - Caisse jaune
Charge utile 250 kg - Réf. HAE0104

110 L

9 995 F

Brouette H'ball
Roue increvable
Caisse orange
Charge utile 100 kg
Réf. BRO1004



100 L

22 995 F

Brouette renforcée
Charge utile 250 kg
Réf. HAE0001



100 L

16 995 F



Brouette Cargo Twin
2 roues gonflées - Caisse jaune
Charge utile 250 kg - Réf. HAE0003

160 L

41 995 F

Diable 200 kg
Roues gonflables
200 mm
Réf. AGE3002

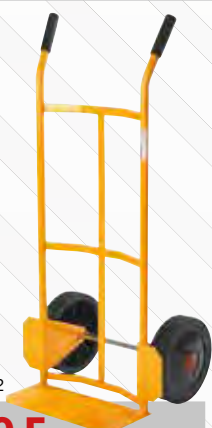

11 990 F

Diable 250 Kg
Roues gonflables
Réf. ALT4003



11 990 F

Diable fixe 200 kg
6 roues increvable
Réf. AGE3004



29 995 F

Diable pro 300 kg
Roues gonflables
Réf. AGE3005

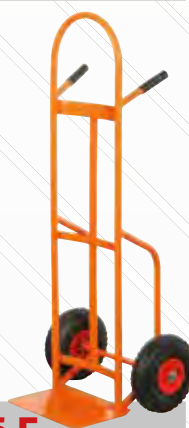

46 995 F



Remorque 600 kg max.
1460 x 990 x 300 mm
Réf. JAT-4058 / SOMO211

149 995 F



Remorque galva 750 kg max.
1880 x 1280 x 300 mm
Réf. JAT-4872 / SOMO212

189 995 F



Remorque galva 750 kg
2530 x 1580 x 300 mm
Réf. JAT-6097 / SOMO213

295 995 F



Transpalette 2 500 kg
Réf. AGE3007

69 990 F



TRAVAUX EN HAUTEUR

ESCABEAU

USAGE DOMESTIQUE



TUBESCA-COMABI



UTILISATION
sol plat

ALUMINIUM

CHARGE MAX.
150 KG

Norme EN 131
Décret 96 333

Nombre de marches	Hauteur en m.	Poids en kg	Réf.	PRIX
3	2,47	2,80	Réf. TUB0021	5 495 F
4	2,67	3,50	Réf. TUB0022	6 895 F
5	2,88	4,30	Réf. TUB0023	7 995 F
6	3,09	5,20	Réf. TUB0024	9 495 F
7	3,30	6,60	Réf. TUB0025	11 490 F
8	3,52	7,50	Réf. TUB0026	13 995 F

PLIANTE ARTICULÉE



0,98 m

0,76 m

0,26 m

TRANSFORMABLE
4 pans
3 positions

UTILISATION
modéré

ALUMINIUM

CHARGE MAX.
150 KG

Norme EN 131-4
Décret 96 333

Hauteur en m.	Poids en kg	Réf.	PRIX
4,37	11,90	Réf. TUB0100	37 495 F

ECHELLE 1 PLAN



TUBESCA-COMABI



UTILISATION
sol plat

ALUMINIUM

CHARGE MAX.
150 KG

Norme EN 131
Décret 96 333

Nombre de marches	Hauteur en m.	Poids en kg	Réf.	PRIX
8	3,17	3	Réf. TUB0250	6 995 F
10	3,73	3,90	Réf. TUB0252	8 995 F
12	4,29	4,70	Réf. TUB0253	9 995 F
14	4,85	6	Réf. TUB0254	11 990 F

ECHELLE

USAGE DOMESTIQUE

StarLine 

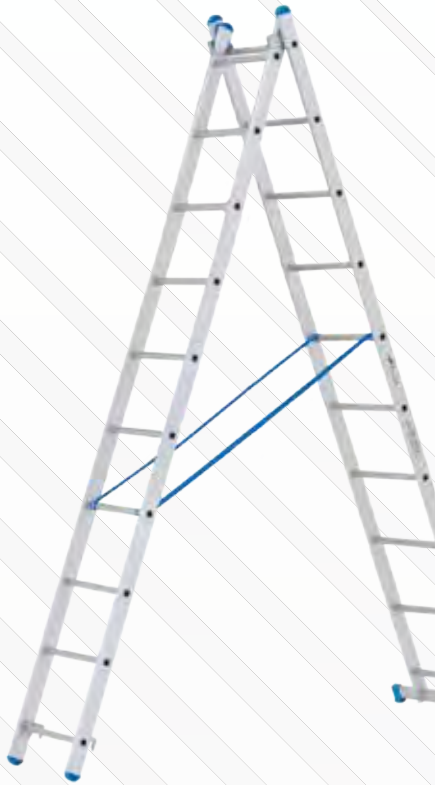

TRANSFORMABLE
2 pans
2 positions

UTILISATION
sol plat

ALUMINIUM

CHARGE MAX.
150 KG

Norme EN 131
Décret 96 333



TRANSFORMABLE
3 pans
4 positions

UTILISATION
sol plat

ALUMINIUM

CHARGE MAX.
150 KG

Norme EN 131
Décret 96 333

Nombre de marches	Hauteur en m.	Poids en kg	Réf.	PRIX
2 x 7	4,29	6,00	Réf. TUB0201	12 995 F
2 x 9	5,13	7,60	Réf. TUB0203	15 995 F
2 x 10	5,69	8,70	Réf. TUB0204	18 995 F
2 x 12	6,81	11,30	Réf. TUB0205	24 990 F

Nombre de marches	Hauteur en m.	Poids en kg	Réf.	PRIX
3 x 8	5,97	10,70	Réf. TUB0202	19 995 F
3 x 11	7,65	15,70	Réf. TUB0209	37 995 F
3 x 12	8,21	17,30	Réf. TUB0210	42 995 F

USAGE PROFESSIONNELS



TRANSFORMABLE
2 pans
4 positions

UTILISATION
ultra intensive

ALUMINIUM

CHARGE MAX.
150 KG

Norme EN 131
Décret 96 333



TRANSFORMABLE
3 pans
5 positions

UTILISATION
ultra intensive

ALUMINIUM

CHARGE MAX.
150 KG

Norme EN 131
Décret 96 333

Nombre de marches	Hauteur en m.	Poids en kg	Réf.	PRIX
2 x 7	4,38	8,90	Réf. TUB0123	42 995 F
2 x 9	5,50	9,60	Réf. TUB0124	54 990 F
2 x 12	6,90	16,30	Réf. TUB0115	62 995 F
2 x 14	8,02	18,60	Réf. TUB0116	99 995 F

Hauteur en m.	Hauteur en m.	Poids en kg	Réf.	PRIX
3 x 9	6,92	18,20	Réf. TUB0117	82 995 F
3 x 10	7,76	20,00	Réf. TUB0131	105 995 F
3 x 12	8,88	22,60	Réf. TUB0118	112 990 F

ÉCHELLE TRANSFORMABLE

USAGE PROFESSIONNEL

PLATE-FORME



HAUTEUR D'ACCÈS MAXI
2,80 m

ALUMINIUM

CHARGE MAX.
150 Kg

Norme LABEL
Décret 2004 924

Plate-forme MINIX 70

Pour travail en espaces intérieurs exigus. Garde-corps rigide pour plus de sécurité

Réf.	Code				PRIX
TUB0515	03152001	26	1	2,80	54 990 F



HAUTEUR D'ACCÈS MAXI
2,80 m

ALUMINIUM

Norme PFG 273



Échafaudage roulant SK 10

Base pliante pour un gain de temps au montage et démontage. Gain de place au rangement : 20 cm plié - Manipulation facile Dimensions hors tout : 1,80 x 0,84 x 1,48 m Dimensions plancher : 1,46 x 0,50 m

Réf.	Code			PRIX
TUB0516	02400110	18,3	2,80	58 995 F

ÉCHAFAUDAGE



HAUTEUR D'ACCÈS MAXI
6,73 m

ALUMINIUM

MONTAGE SANS VIS NI CLOUS

Norme NFE 85200

Échafaudage roulant

FIRST 5/7 PRESTO

Ultra léger, mise en place et déplacements rapides.

Plateau réglable tous les 30 cm

Kit escalier intégré - Roues de déplacement

Accès par l'intérieur par plateau à trappe.

Hauteur plancher **FIRST 5** : 2,43 m - **FIRST 7** : 4,73 m

Dimensions plancher : 1,46 x 0,50 m

Réf.	Code			PRIX
TUB0503	02400905	25	4,43	54 990 F
TUB0531	02400907	53,22	6,73	129 995 F



HAUTEUR D'ACCÈS MAXI
7,70 m

ALUMINIUM

MONTAGE SANS VIS NI CLOUS

Norme EN 1004
Décret 2004 924

Échafaudage roulant

T-ONE 155 Pliant

Barre de montage brevetée pour montage et démontage sécurisé

Dimensions mini au sol : 1,75 x 0,79 m

Dimensions plancher : 1,41 x 0,80 m

Trappe : 0,60 x 0,55 m

Réf.	Code			PRIX
TUB0522	22401532	54,50	4,70	149 995 F
TUB0521	22401562	85,30	7,70	259 990 F



HAUTEUR D'ACCÈS MAXI
7,80 m

ALUMINIUM

MONTAGE SANS VIS NI CLOUS

Norme EN 1004
CLASSE 3

Échafaudage roulant

NÉOLIUM 3X

Réf.	Code			PRIX
TUB0533	02920004	106	5,60	315 990 F
TUB0535	02920006	124	7,80	375 995 F

Échafaudage roulant ALUXIS JUNIOR 80
 Spécialement conçu pour les professionnels
 de la décoration et de la peinture
 Roues avec frein - Base pliable
 Dimensions base : 0,80 x 1,60 m
 Plancher alu-bois : 0,65 x 1,60 m



**HAUTEUR
 D'ACCÈS MAXI
 3,80 m**

**ALUMINIUM
 ANODISÉ**

**CHARGE MAX.
 200 Kg**

**TRAPPE
 RABATTABLE**

**Décret du
 01 09 2004**

Réf.	Code			PRIX
ALTO020	612302	50	3,80	179 995 F



**NORME
 EN 353-2 2002**

Coulisseau COBRA
 Coulisseau automatique pour
 corde toronnée, avec mousqueton
 Code: 8011001 - Réf. CEV603

34 995 F



ACIER

**VÉRROUILLAGE
 MANUEL**

**OUVERTURE
 MANUELLE**

**Norme
 EN 36202004**

Mousqueton à vis
 Code: 812001 - Réf. CEV605

1 895 F

POLYAMIDE

ø 36 mm

**Norme
 EN 353-2 2002**



Cordage pour coulisseau COBRA

Avec fil d'identification et témoin d'usure comportant une boucle épaissée
 et un mousqueton - Code: 810004 - Réf. CEV604

12 995 F



Kit harnais + accessoires
 Réf. AGE6010

12 295 F



Harnais antichute 2 points
 Réf. AGE6011

5 595 F



**Norme
 EN 361 2002**

Harnais 1 point
 Réglage complet cuissardes et
 bretelles - D d'accroche dorsal
 Code: 800001 - Réf. CEV601

9 995 F



**Norme
 EN 361 2002**

Harnais 2 points
 Réglage complet cuissardes et
 bretelles - D d'accroche dorsal
 Accrochage sternal double boucle
 Code: 800003 - Réf. CEV602

14 995 F



PROTECTION

YEUX



Lunette + coque perforée
Réf. CEV004

390 F



Lunette ALIZÉ incolore
Réf. CEV001

495 F



Lunette + coque
Réf. UVE0111

1 695 F

AUDITIVE

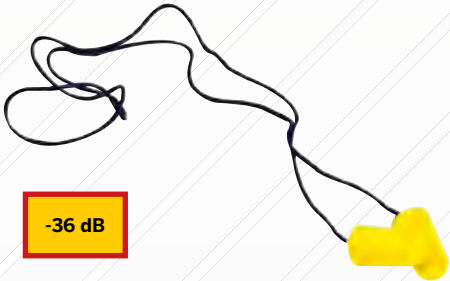

-36 dB

Bouchon d'oreilles
Réf. TAL1265

290 F



-25 dB

Casque anti-bruit
Réf. AGE8002

1 290 F



-25 dB

Casque anti-bruit
Réf. AGE8003

2 495 F

TÊTE



Divers coloris

Casque OCEANIC
Réf. TAL1201 à TAL1206

690 F



Casquette anti-heurt
3 couleurs disponibles
Taille unique
Réf. AGE6040 à AGE6042

2 495 F



Divers coloris

Casque ORIZON
Réf. TAL1270 à TAL1274

3 290 F

VOIES RESPIRATOIRES



Demi-masque FFPI
avec valve - Par boîte de 12 unités
Réf. AGE7020

2 195 F



Demi-masque + filtre de rechange
Réf. AGE7012 - AGE7014

5 580 F



Demi-masque
avec lunette
Réf. AGE7030

7 995 F



MAINS



Gant de docker
Réf. CEV203

495 F



Gant CAPTAIN
BATMAT
Réf. MANU003

390 F



Gant
MAXI FLEX
Réf. AGE6105

1 295 F

TEXTILE



Gilet de
signalisation
Taille S > XXXL
Réf. SOM0501 à SOM0506

695 F

5
personnes



Trousse
de secours
Réf. AGE7042

5 995 F



Cone PVC
hauteur : 45 cm
Disponible en hauteur 70 cm
Réf. SOM0510

1 495 F



Pantalon de travail
LEE COOPER
Noir - 245 g
Taille 38 > 54
Réf. LEE2501 à LEE2507

5 295 F

Gao coton
bleu
Taille M à
XXXL
Réf. GAO0001 à
GAO0005

1 995 F



Veste BUGATTI
bleue
Taille 36 > 62
Réf. CEV0301
à CEV0314

2 995 F



Short de travail
LEE COOPER
Gris - 245 g
Taille 38 > 54
Réf. LEE2001 à LEE2007

4 290 F

Short BUGATTI bleu
Taille 36 > 62
Réf. MUZ0001 à MUZ0014

1 995 F

Pantalon BUGATTI bleu
Taille 36 > 62
Réf. CEV0315 à CEV0328

2 995 F



CHAUSSURES DE SÉCURITÉ

PARTICULIER ET PROFESSIONNEL - COMMERCE, DISTRIBUTION ET LOGISTIQUE



SÉLECTION SOMAC
MATÉRIEL DE CONSTRUCTION

Dakar
Réf. CEV317 à CEV324

40 < 47

2 995 F

résistance aux huiles et hydrocarbures

antichoc

antistatique

antiperforation

coque de protection

semelle antidérapante

S1P



NORME S1 PROTECTION RÉGLEMENTAIRE



Macstopac
Réf. HEC0241 à HEC0252

36 < 47

6 995 F



Nevada Basse
Réf. FOX0013 à FOX0020

41 < 48

7 495 F



Daurie Blanc
Réf. PAR0281 à PAR0287

36 < 42

6 995 F



Valley
Réf. PAR0001 à PAR0007

42 < 48

6 495 F



Chaussure sécurité Laguna
Réf. PAR0112 à PAR0123

36 < 47

7 995 F



Lavana
Réf. PAR0132 à PAR0143

36 < 47

7 995 F



Austin
Réf. GER0121 à GER0129

39 < 47

7 995 F



Celise Blanche
Réf. PAR0271 à PAR0277

36 < 42

7 995 F



Pink basse
Réf. FOX0004 à FOX0007

38 < 41

9 995 F



Noir basse
Réf. LEE3052 à LEE3055

41 < 44

9 995 F



SRA Gris basse
Réf. LEE3071 à LEE3076

41 < 46

9 995 F



SRA Noir basse
Réf. LEE3061 à LEE3066

41 < 46

11 990 F



Macspeed
Réf. HEC0161 à HEC0173

36 < 48

13 995 F



SRC Noir haute
Réf. LEE3031 à LEE3036

41 < 46

11 990 F



Run-R 210
Réf. HEC0001 à HEC0012

37 < 48

11 990 F



SRA Noir/gris Basse
Réf. LEE3001 à LEE3006

41 < 46

13 995 F

ESPACES VERTS, INDUSTRIE, BTP, EXTÉRIEUR, TOITURE



SÉLECTION SOMAC
MATERIAUX DE CONSTRUCTION

Chicago haute
Réf. FOX0074 à 83

39 < 48

2 995 F



résistance aux huiles et hydrocarbures — déperlant

antichoc — coque de protection

antistatique — semelle antidérapante

antiperforation

S3

DIL, H, L, P, S, T, U, V



Mustang basse
Réf. FOX0055 à FOX0061

41 < 47

6 995 F



Mustang haute
Réf. FOX0035 à FOX0041

41 < 47

7 095 F



Kansas
Réf. PAR0101 à PAR0110

39 < 48

8 995 F



Atena
Réf. PAR0031 à PAR0037

42 < 47

8 995 F



Liverpool
Réf. CEV325 à CEV339

39 < 47

9 995 F



Dana Noir
Réf. PAR0242 à PAR0248

36 < 42

8 495 F



Nitrax
Réf. PAR0080 à PAR0086

42 < 48

6 996 F



First
Réf. PAR0040 à PAR0046

42 < 48

8 995 F



Mascole
Réf. HEC0201 à HEC0213

36 < 48

12 995 F



Truck
Réf. PAR0192 à PAR0204

39 < 51

12 995 F



Macrossroad
Réf. HEC0076 à HEC0088

36 < 48

13 995 F



Run-R 300
Réf. HEC0031 à HEC0042

37 < 48

10 990 F

LA NORME S5
Tous environnements de travail, industrie, BTP, Agriculture...

EN ISO 20345 : 2011 - S3

- arrière fermé
- propriétés antistatiques
- absorption d'énergie au talon
- semelle résistante aux hydrocarbures
- semelle anti-perforation
- semelle de marche à crampons

LOGISTIQUE, SECOND ŒUVRE, ESPACES VERTS, INDUSTRIE



39 < 47

Botte sécurité Devon
Réf. GER0071 à GER0079

2 790 F



40 < 47

Botte sécurité
Réf. AGE9020 à AGE9027

2 995 F



40 < 47

Botte sécurité Swan Master
Réf. CEV401 à CEV408

4 495 F

NORME S3 PROTECTION RENFORCÉE

NORME S5



OUTILLAGE D'ATELIER

GROUPE ÉLECTROGÈNE ARTISAN

ESSENCE - MANUEL



SPG2500
2 KVA - 60 Hz
Réf. SOM0035

2 000 W

15 L 12H

44 995 F



GEE3800
3,10 KVA - 60 Hz - 3 500 W
Réf. SOM0006

15 L 12H

79 995 F

ESSENCE MANUEL - ÉLECTRIQUE



GEE8500E2
6,6 KVA - 60 Hz
Réf. SOM0010

6 000 W

25 L 15H

165 995 F



NG2200
1 KVA
Réf. KIP0033

1 100 W

7 L 10H

37 995 F



NG2900
2 KVA
Réf. KIP0031

2 200 W

13 L 10H

54 990 F



NG7990E
5 KVA
Réf. KIP0032

5 500 W

25 L 8H30

119 995 F

DIÉSEL - MANUEL - ÉLECTRIQUE



NDG2500CLE
2 KVA
Réf. KIP0020

2 000 W

12,5 L 12H

117 995 F



NDG5000CLE
5 KVA
Réf. KIP0021

5 000 W

12,5 L 5H30

169 995 F



NDG5000SE
5 KVA
Réf. KIP0025

5 000 W

15 L 5H30

**MODÈLE
INSONORISÉ**

234 995 F



NDG8500CLE
7 KVA
Réf. KIP0022

6 500 W

12,5 L 5H30

224 995 F



**Huile MOBIL
SL 15W40
DELVAC - 5 L**
Réf. HUIL0024

3 470 F

COEFFICIENT DE DÉMARRAGE

Type de matériel	Coef.	Exemple de puissance en watts	Puissance de démarrage nécessaire maxima en watts
Ampoule	1	10	10
Scie circulaire	1,2	600	720
Perceuse	1,2	630	756
Méleuse	1,2	700	840
Perforateur	1,2	950	1140
Ponceuse	1,2	440	528
Aspirateur	1,2	1400	1680
Bétonnière	3	850	2550
Réfrigérateur	3,5	400	1400
Congélateur	3,5	450	1575
Machine à laver	3,5	1500	5250

GROUPE ÉLECTROGÈNE PROFESSIONNEL

COMPRESSEUR ARTISAN



Air+ 24 L
2 HP avec accessoires
Réf. SOM0019

24 990 F



Air+ 50 L
2,5 HP - 1,8 KW avec accessoires
Réf. SOM0017

26 990 F



**Accessoires
tout compresseur**

Air+ 100 L
3 HP - 2,2 KW avec accessoires
Réf. SOM0018

77 995 F



Air+ 150 L
9 HP avec accessoires
Réf. SOM0020

72 995 F

TABLEAU DES PERFORMANCES

Usages	Performances			
	50 L	100 L	150 L	à partir de 200 L
Agrafage	X	X	X	X
Gonflage	X	X	X	X
Peinture	X	X	X	X
Pistolet à colle	X	X	X	X
Perçage		X	X	X
Marteau burineur		X	X	X
Pulvérisation		X	X	X
Peinture PRO		X	X	X
Clé à chocs			X	X
Sablage et ponçage				X

COMPRESSEUR PROFESSIONNEL



AirBlock 50 L
60 Hz
Réf. AGE2005

54 990 F



AirBlock 100 L
60 Hz
Réf. AGE2006

109 995 F



AirBlock 200 L
60 Hz
Réf. AGE2007

164 995 F

ACCESSOIRE



Tuyaux 25 m
Réf. LAC0022

8 995 F



Kit MF 3 accessoires
Réf. LAC0012

6 990 F



**Pistolet
à peinture
à gravité**
Réf. LAC0007

9 495 F



Pistolet à peinture PRO
Réf. LAC0006

9 695 F



SOUDURE MMA

PROCESS

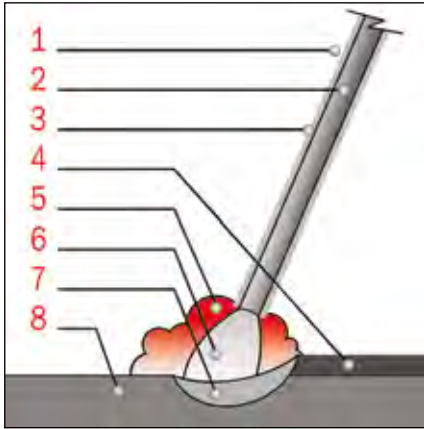

- 1 • Électrode
- 2 • Âme
- 3 • Revêtement
- 4 • Scorie
- 5 • Protection gazeuse
- 6 • Arc de soudage
- 7 • Bain de fusion
- 8 • Matériau de base

CARACTÉRISTIQUES

- + Aspect pratique extrême
- + Haut économique
- + Pas de bouteille de gaz
- + Soudage toutes positions
- Productivité limitée
- Élimination scories de la pièce

INTENSITÉ DE SOUDAGE

épaisseur soudable à plat bord à bord et en angle (mm)	Diamètre d'électrode (mm)	Intensité moyenne (A)
1,6	1,6	40
2,0	2,0	55
2,0 - 3,0	2,5	70
3,0 - 5,0	3,2	110
3,0 - 10,0	4,0	160
> 8,0	5,0	200
> 10,0	6,3	290

INVERTER VS ELECTROMECHANICAL

Caractéristiques	Inverter	Traditional
Encombrement et poids	++++	++
Stabilité courant	+++++	++
Consommation d'énergie	+++++	++
Type d'électrode utilisée	++++	+
Contrôle qualité soudage	+++++	+
Performances globales	+++++	++

150 Amp.



Poste à souder - 170 Amp.
Inverter - INFINITY 170
Réf. AGE0359

22 995 F

160 Amp.



Poste à souder Inverter - 170 Amp.
+ casque électronique
Réf. IMS0009

KIT TORCHE TIG
REF : IMS0265

32 995 F

POSTE INVERTER

200 Amp.



Poste à souder Inverter - 200 Amp.
Réf. IMS0003

34 995 F

200 Amp.



Poste à souder Inverter - 200 Amp.
Ecran digital
Réf. IMS0004

44 995 F

200 Amp.



Poste à souder - 200 Amp.
Inverter - INFINITY 200
Réf. AGE0382

47 995 F

200 Amp.



Poste à souder Inverter - 200 Amp.
FLEX VOLTAGE 400 V.
Réf. IMS0005

67 995 F



Poste à souder Inverter
186 MPGE
Réf. AGE0399

69 990 F



Poste à souder Inverter
AMP-238CE
Réf. AGE0400

84 990 F

SOUDURE MIG/MAG



140 Amp.

- Alu
Ø 0,8 mm à 1 mm
- Inox
Ø 0,8 mm
- Acier
Ø 0,6 mm à 0,8 mm
- Fil fourré
Ø 0,8 mm à 1,2 mm

Poste à souder
Maxima 190 - MIG / MAG
Réf. AGE0383

54 990 F

140 Amp.

- Alu
Ø 0,8 mm à 1 mm
- Inox
Ø 0,8 mm
- Acier
Ø 0,6 mm à 0,8 mm
- Fil fourré
Ø 0,8 mm

Poste à souder
TELMIG 180/2
Réf. AGE0302

99 995 F

PROCESS

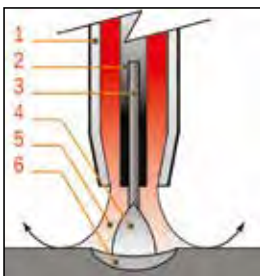

- 1 • Bec
- 2 • Tube contact
- 3 • Fil électrode
- 4 • Arc de soudage
- 5 • Protection gazeuse
- 6 • Bain de fusion

NO GAZ/FLUX WELDING

- + Utilisation immédiate
- + Aspect pratique extrême (pas de bouteille)
- + Utilisation à l'air libre
- Scories à éliminer
- Coût fil fourré

CARACTÉRISTIQUES

- + Technique d'assimilation simple
- + Haute productivité
- + Absence de scories
- + Basse fréquence de fumées
- Bouteilles de gaz
- Utilisation limitée à l'air libre

WELDING CIRCUIT



Fil fourré

Soudure sans apport de gaz
(uniquement pour l'acier)

Alu

Soudure avec gaz - 100 % argon

Inox

Soudure avec gaz - Mix argon/CO₂

Acier

Soudure avec gaz - Mix argon/CO₂ ou 100 % argon

MULTIPROCESS MMA, MIG ET MAG

140 Amp.



Poste à souder
Multi process
140 Amp.
Réf. AGE0437

112 990 F

- Alu
Ø 0,8 mm à 1 mm
- Inox
Ø 0,8 mm
- Acier
Ø 0,6 mm à 0,8 mm
- Fil fourré
Ø 0,8 mm à 1,2 mm

140 Amp.



Poste à souder
Multi process
140 Amp.
Réf. IMS0038

79 995 F

- Alu
Ø 0,8 mm
- Inox
Ø 0,8 mm
- Acier
Ø 0,6 mm à 0,8 mm
- Fil fourré
Ø 0,8 mm

200 Amp.



Poste à souder
Multi PROCESS
200 Amp.
2010-4
Réf. IMS0042

159 995 F

- Alu
Ø 0,8 mm à 1 mm
- Inox
Ø 0,8 mm à 1 mm
- Acier
Ø 0,6 mm à 1 mm
- Fil fourré
Ø 0,8 mm à 1,2 mm

POSTE INVERTER



SOUDURE

DÉCOUPEUR PLASMA

DÉCOUPEUR PLASMA

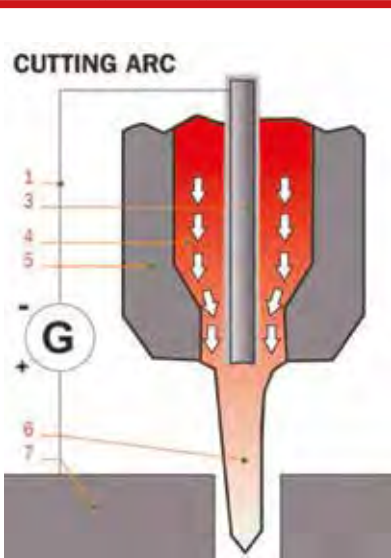

- 1 • Circuit d'amorçage
- 2 • Circuit de découpage
- 3 • Cathode
- 4 • Gaz
- 5 • Bec
- 6 • Arc de découpage
- 7 • Métal



10 À 35 AMP MAX.

	ACIER INOX FONTE	ALU
Épaisseur max. coupe classique	12 mm	8 mm
Épaisseur max. coupe précise	8 mm	6 mm

Découpeur plasma 35kf
IMS - 230 V - 50/60 Hz
Réf. IMS0100

139 995 F



10 À 40 AMP MAX.

	ACIER INOX FONTE	ALU
Épaisseur max. coupe classique	15 mm	10 mm
Épaisseur max. coupe précise	10 mm	8 mm

Découpeur plasma 40vf
IMS - 230 V - 50/60 Hz
Inverseur C sans compresseur
Réf. IMS0101

149 995 F

ACCESSOIRE

CASQUE À SOUDURE

Casque à souder manuel
TIGER
Réf. AGE0364



3 995 F

Casque à souder électronique
LCD TECHNO
Réf. IMS0152



4 990 F

Casque à souder électronique
FARTOOLS
Réf. FAR0130



8 995 F

Casque à souder
TAURUS
Réf. AGE0436



12 495 F

Casque à souder électronique
JAGUAR FIRE
Réf. AGE0385



16 995 F

Casque à souder
ALIEN XXL
Réf. IMS0385



22 995 F



ACCESSOIRES SOUDURE



Positionneur Magnetic
pour soudure
Réf. IMS0210

2 495 F



Positionneur Magnetic
pour soudure P16
Réf. IMS0220

1 295 F



Porte électrode
Jusqu'à 300 Amp.
Réf. IMS0200

1 790 F



Gant spécial soudure XXL
Réf. AGE0354

2 495 F



Etau angulaire
pour soudure
Réf. FAR7009

4 690 F



Brosse de soudure
Réf. AGE0352

1 890 F

CONSOMMABLE MMA



Electrode G48N
Ø 2,5 x 250 pcs
Réf. CEN0012
Disponible en Ø 3,2

1 995 F

CONSOMMABLE MIG/MAG



Fil fourré
Ø 0,9 mm - 0,9 kg
Réf. IMS0430

1 995 F



Fil alu
Ø 0,8 mm
Réf. IMS0439

2 590 F



Spray soudure
Anti corrosion
Réf. AGE0424

1 165 F



Fil inox
Ø 0,8 mm - 1 kg
Réf. IMS0449

3 995 F



Bouteille de butane
330 gr
Réf. AGE0358

1 290 F



OUTILLAGE ÉLECTROPORTATIF

18 VOLT



**Kit perforateur
+ visseuse à choc
+ 2 batteries 5 ah
18V,
DCD791P887NT - Réf. DEW0173**

67 995 F



**Marteau
perforateur SDS
1 050W, Ø 40 mm
D25810K-QS - Réf. DEW0325**

59 995 F



**Kit perceuse
+ scie circulaire
+ 2 batteries 5 ah
18V
Réf. DEW0176**

63 995 F

18 VOLT



**Perceuse visseuse
BRUSHLESS
18V - 4 ah
DCD777M2T - Réf. DEW0176**

41 990 F



**Perceuse à percussion
650W - fillaire
DWD024KS - Réf. DEW0202**

17 995 F

18 VOLT



**Perceuse à percussion
+ 2 batteries
18V, 5AH
DCD996P2 - Réf. DEW0169**

73 995 F



**Perforateur SDS
+ accessoires offerts
Ø 26 mm
D25134K-QS - Réf. DEW0317**

29 995 F



**Perceuse à percussion
+ charbon offert
1 100W - fillaire
DWD524KS - Réf. DEW0210**

33 995 F



**Robot laser
en croix + trépied
DW088KIRI
Réf. DEW0908**

63 995 F



**Marteau de démolition
179 joules
D258999K - Réf. DEW0354**

159 995 F



**Perceuse à percussion
1 300W - fillaire
DWD530KS - Réf. DEW0206**

42 995 F

DEWALT



Tronçonneuse à lame

Ø 355 mm
2 200W
DW872 - Réf. DEW0651



123 995 F

Combo meuleuse

(fournis sans les disques)
Ø 230 mm + Ø 125 mm
2 200W + 900W
DWE492 TWIN2
Réf. DEW0449



34 990 F

Scie sauteuse 701W

DW331K - Réf. DEW0503



35 990 F

Tronçonneuse

2 200W, Ø 355 mm
D28715-QS - Réf. DEW0653



62 995 F

DEWALT

ROBUSTESSE GARANTIE

Scie circulaire

1 600W, Ø 190 mm
Découpe jusqu'à 67 mm d'épaisseur
DWE575K - Réf. DEW0558



29 995 F

Rabot de chantier

DW733 - 1800W - Réf. DEW0803



139 995 F

SÉLECTION **SOMAC**
MATERIAUX DE CONSTRUCTION

Meuleuse

1 400W, Ø 125 mm
DWE4237-QS - Réf. DEW0448



14 995 F

Scie circulaire

1 750W, Ø 235 mm
Découpe jusqu'à 86 mm d'épaisseur
D23700 - Réf. DEW0556



53 990 F

Ponceuse excentrique

280W, Ø 125 mm
Réf. DEW0734



17 995 F

18 VOLT

XR
LITHIUM ION
UNIVERSAL

Souffleur 18U

+ batterie 5 aH
DCM562PI-QW - Réf. DEW0980



39 990 F

Scie radiale + trépied

1 300W, Ø 216 mm
DWS773-QS - Réf. DEW0616



66 995 F

DEWALT



OUTILLAGE ÉLECTROPORTATIF



PRO 18v

Perceuse-visseuse à choc
18V + 2 batteries 4 aH
Réf. AEG0016

49 995 F



Meuleuse
(fournis sans les disques)
Ø 230mm, 2 200W
WS22-230DMS - Réf. AEG0085

19 995 F



Scie sauteuse
700W
STEP100X
Réf. AEG0112

14 995 F



**PRO 18v
BRUSHLESS**

Perceuse-visseuse à percussion
18V + 2 batteries 5 aH
BSB18CBL-Li-502C
Réf. AEG0010

44 995 F



Scie circulaire filaire
Ø 190mm, 1 600W
KS662 - Réf. AEG0123

24 990 F

AEG



**PRO 18v
BRUSHLESS**

Perceuse à percussion
+ 1 batterie 4 aH offerte
18V, + 1 batterie 2 aH
Réf. AEG0015

39 990 F



Meuleuse
(fournis sans les disques)
Ø 125 mm, 800W
WS8-125S - Réf. AEG0087

9 995 F



Ponceuse excentrique
+ 25 plateaux
Ø 125 mm, 300W
EX125EDSET - Réf. AEG0136

13 995 F



Perforateur burineur SDS+
800 W
BH24IE - Réf. AEG0025

19 995 F



Perceuse à percussion filaire
705 W
SBE705RE - Réf. AEG0047

11 990 F



Perceuse à percussion filaire
750 W
SB2E750RZ - Réf. AEG0048

12 990 F

OUTILLAGE ÉLECTROPORTATIF



POWER TOOL
ALL 18 V



Perceuse visseuse + accessoires
18V, 2 batteries 3 aH
GSR18 - Réf. BOS0051

34 995 F



Combo meuleuses
(fournis sans les disques)
230mm + 125mm, filaire
GWS850C - Réf. BOS0401

32 995 F



Caroteuse
2000 W
GDB180WE - Réf. BOS1501

187 995 F



Perforateur burnineur SDS+
880 W
GBH2-28F - Réf. BOS0302

39 990 F



Scie circulaire
850W, Ø130 mm
découpe jusqu'à
26 mm d'épaisseur
PSK40 - Réf. BOS0901

14 995 F



Perceuse à percussion
600W
GSB13RE - Réf. BOS0201

12 995 F



Meuleuse
(fournis sans les disques)
720W, Ø 125 mm
GWS7-125 - Réf. BOS0425

11 990 F



Perceuse visseuse Easy Impact 550
550W
EASYIMPACT550 - Réf. BOS0701

8 995 F

SPÉCIAL PLACO

Aspirateur de colmatage
Cuve 35L, 1200 W
GAS35MAFC - Réf. BOS0041

119 995 F



Ponçeuse excentrique
Ø 125 mm, 250W
GEX125_1AE - Réf. BOS0581

27 995 F



Ponçeuse excentrique
Ø 125 mm, 250W
PEX220A - Réf. BOS1001

9 995 F

BOSCH



OUTILLAGE ÉLECTROPORTATIF

18 V
Battery System



Perceuse visseuse
+ 2 batteries 3 Ah
Réf. FAR1503

22 995 F



Perforateur SDS +
1 050W
MP50D - Réf. FAR2001

12 995 F



Perceuse sur étable
350W
Réf. FAR2003

27 995 F



18 V
Battery System

Perceuse visseuse
+ 2 batteries 1,5 aH
Réf. FAR0189

15 995 F



Grignoteuse
600W, Ø2 mm
Réf. FAR3751

18 995 F

14 V
Battery System



Perceuse 14V
+ 2 batteries 14,4 V
LM144C - Réf. FAR0185

12 995 F



Perceuse à percussion
1 200W
Réf. FAR0012

12 995 F



Rénovateur
+ brosse
1 300W
Réf. FAR0306

13 995 F

18 V
Battery System



Clés à choc
+ 2 batteries 3 aH
18 V, 3 Ah
CH280 - Réf. FAR1103

34 995 F



Perceuse à percussion
850W
PP850 - Réf. FAR0108

7 995 F



Brise béton SDS
1 500W
MP50D - Réf. FAR2002

29 995 F

FAR TOOLS



Rabot dégaucheuse
1500 W
Réf. FAR5503

59 995 F



Scie sauteuse pendulaire
800W
JS7100 - Réf. FAR0054

8 495 F



Meuleuse
Ø230mm, 2200W
Réf. FAR0004

13 995 F



Scie à onglet réversible + table
1800W
FS254-JR255B - Réf. FAR0067

99 990 F



Meuleuse
Ø125 mm, 910W
Réf. FAR0006

5 295 F



Rabot électrique
600W
Réf. FAR0048

5 295 F



Scie circulaire
Ø185 mm, 1400W
Réf. FAR0135

13 295 F



Ponçeuse
Ø225 mm, 710W
DWS710E - Réf. FAR5001

18 995 F



Ponçeuse orbitale
Ø125 mm, 450W
Réf. FAR0015

6 690 F



Scie sabre
710W
RS710 - Réf. FAR0084

8 995 F



ACIER PRÉPEINT

POUTRELLE - Acier qualité S235 JR

IPE		Longueur 6 m			Longueur 9 m			Longueur 12 m		
		H en mm	Réf.	PRIX	H en mm	Réf.	PRIX	H en mm	Réf.	PRIX
		80	BIP0806	7 995 F	-	-	-	80	BIP0812	15 991 F
		100	BIP1006	9 310 F	100	BIP1009	14 490 F	100	BIP1012	19 320 F
		120	BIP1206	12 520 F	120	BIP1209	18 945 F	120	BIP1212	25 260 F
		140	BIP1406	15 565 F	140	BIP1409	23 500 F	140	BIP1412	31 520 F
		160	BIP1606	16 642 F				160	BIP1612	37 815 F
		180	BIP1806	22 195 F				180	BIP1812	44 595 F
		200	BIP2006	26 436 F				200	BIP2012	53 135 F
		220	BIP2206	30 635 F				220	BIP2212	61 635 F
		240	BIP2406	36 305 F				240	BIP2412	73 020 F
		270	BIP2706	42 450 F				270	BIP2712	85 686 F
		300	BIP3006	45 849 F				300	BIP3012	99 395 F

Les prix des aciers sont à titre indicatif et fluctuent en fonction des arrivages.

UPN		Longueur 6 m			Longueur 12 m		
		H en mm	Réf.	PRIX	H en mm	Réf.	PRIX
		80	BUN0806	9 922 F	80	BUN0812	19 844 F
		100	BUN1006	12 025 F	100	BUN10	24 050 F
		120	BUN1206	15 202 F	120	BUN1212	30 404 F
		140	BUN1406	18 152 F			
		200	BUN2006	30 534 F			

UAC		Longueur 6 m		
		Dimensions en mm	Réf.	PRIX
		40 x 20 x 5	BUP04	3 310 F
		50 x 38 x 5	BUP05	4 452 F
		60 x 30 x 6	BUP06	5 848 F
		70 x 40 x 6	BUP07	7 808 F

HEA		Longueur 6 m		
		H en mm	Réf.	PRIX
		-	-	-
		100	BHE1061	21 735 F
		120	BHE1261	25 901 F



Disque à tronçonner
 Ø 115 : Réf. FDR0114
 Ø 125 : Réf. FDR0115 - 195 F
 Ø 150 : Réf. FDR0116 - 220 F
 Ø 230 : Réf. FDR0117 - 295 F

À partir de 165 F



Peinture anti-rouille
 ASTRAL
 9 coloris
 0,5 L - 6 m²
 2 L - 24 m² - 6 995 F

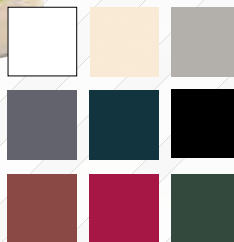

À partir de 1 695 F



Peinture anti-rouille
 PHILOPHER
 6 coloris
 5 KG - 40 m²
 25 KG - 200 m² - 33 795 F

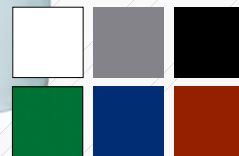

À partir de 8 295 F

TUBE DE CONSTRUCTION - Acier qualité S235 JR

CARRÉS		Longueur 6 m - Épaisseur 3 mm		
		Dimensions en mm	Réf.	PRIX
		30 x 30	BCP030	2 864 F
		40 x 40	BCP040	3 841 F
		50 x 50	BCP050	5 094 F
		60 x 60	BCP060	6 024 F
		80 x 80	BCP080	8 214 F
		100 x 100	BCP100	10 412 F

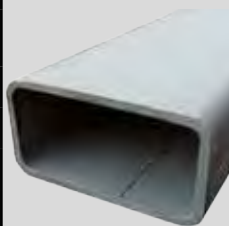
RECTANGLES		Longueur 6 m - Épaisseur 3 mm		
		Dimensions en mm	Réf.	PRIX
		40 x 30	BRP0403	3 050 F
		50 x 30	BRP0503	3 854 F
		60 x 30	BRP0603	4 129 F
		60 x 40	BRP0604	4 576 F
		80 x 40	BRP0804	6 348 F
		100 x 50	BRP1005	7 408 F

FER CARRÉ PLEIN

	Longueur 6 m - Épaisseur 3 mm		
	Dimensions en mm	Réf.	PRIX
	10 x 10	BKP010	850 F
	12 x 12	BKP012	1 223 F
	14 x 14	BKP014	1 667 F
16 x 16	BKP016	2 174 F	

CORNIÈRE

	Longueur 6 m - Épaisseur 3 mm		
	Dimensions en mm	Réf.	PRIX
	40 x 40 x 4	BLP404	2 805 F
	45 x 45 x 4,5	BLP4545	3 568 F
	50 x 50 x 5	BLP505	4 425 F
	60 x 60 x 6	BLP606	6 701 F
80 x 80 x 8	BLP808	11 145 F	

FER PLAT

	Longueur 6 m			
	Largeur en mm	Épaisseur	Réf.	PRIX
	40	4	BPP0404	1 442 F
		10	BPP0410	3 613 F
	50	4	BPP0505	2 595 F
		6	BPP0606	3 455 F
	80	6	BPP0806	4 268 F
		8	BPP0808	5 781 F
	100	6	BPP1006	5 499 F
		10	BPP1010	8 877 F
	120	6	BPP1206	6 975 F
	150	8	BPP1508	8 493 F
	200	10	BPP2010	19 247 F

FER TE

FER TE		Longueur 6 m		
		Dimensions en mm	Réf.	PRIX
		30 x 30 x 4	BTP304	2 236 F
		40 x 40 x 5	BTP404	3 661 F
		50 x 50 x 6	BTP506	5 432 F



ACIER GALVANISÉ

POUTRELLE - Acier qualité Q195



Fer OMEGA Galva
60 x 35 x 3 mm - Longueur 6 m
Réf. BOGALVA

5 255 F

POUTRELLE - Acier qualité S235 JR

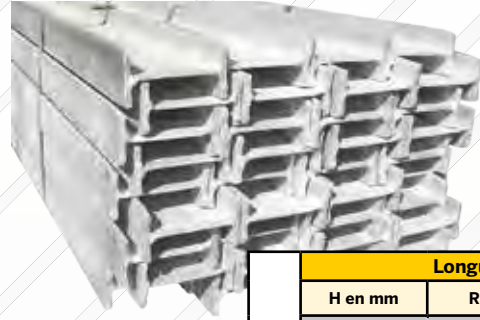

IPE	Longueur 6 m		
	H en mm	Réf.	PRIX
	80	BIPG086	9 810 F
	100	BIPG106	13 260 F
	120	BIPG126	16 975 F
	140	BIPG146	21 090 F

CORNIÈRE



Longueur 6 m

Largeur en mm	Réf.	PRIX
20 x 20 x 3	BLG203	1 650 F
25 x 25 x 3	BLG253	1 745 F
30 x 30 x 3	BLG303	2 095 F
35 x 35 x 3,5	BLG3535	2 615 F
40 x 40 x 4	BLG404	2 995 F
50 x 50 x 5	BLG505	5 345 F
63 x 63 x 6	BLG606	7 100 F
80 x 80 x 8	BLG808	12 245 F

FER PLAT



Longueur 6 m

Largeur en mm	Épaisseur	Réf.	PRIX
20	3	BPG0203	935 F
	10	BPG0210	2 895 F
25	4	BPG0254	1 445 F
30	4	BPG0304	1 735 F
40	4	BPG0404	1 915 F
	10	BPG0410	4 790 F
50	5	BPG0505	2 995 F
60	6	BPG0606	4 205 F
80	6	BPG0806	5 610 F
	8	BPG0808	7 480 F
100	6	BPG1006	7 015 F
	10	BPG1010	11 690 F
120	6	BPG1206	8 680 F
150	6	BPG1506	10 850 F
	8	BPG1508	14 450 F
200	6	BPG2006	14 465 F
	10	BPG2010	24 110 F

IPE - UPN - HEA - UAC

TUBE DE CONSTRUCTION - Acier qualité S235 JR

CARRÉ

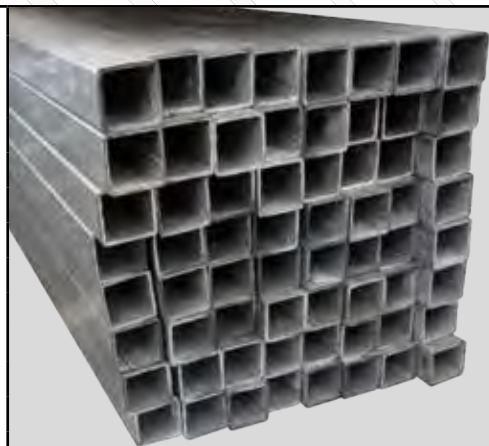

Longueur 6 m - Épaisseur 1,5 mm		
Dimensions en mm	Réf.	PRIX
20 x 20	BCG1003	1 415 F
25 x 25	BCG1005	1 590 F
30 x 30	BCG1007	2 260 F
35 x 35	BCG1008	2 670 F
40 x 40	BCG1009	2 965 F

Longueur 6 m - Épaisseur 2 mm		
Dimensions en mm	Réf.	PRIX
20 x 20	BCG2003	1 750 F
30 x 30	BCG2007	2 440 F
35 x 35	BCG2008	3 635 F
40 x 40	BCG2009	3 890 F

Longueur 6 m - Épaisseur 3 mm		
Dimensions en mm	Réf.	PRIX
50 x 50	BCG3011	5 525 F
60 x 60	BCG3013	6 620 F
80 x 80	BCG3015	8 940 F
100 x 100	BCG3017	11 520 F
120 x 120	BCG3019	14 395 F
150 x 150	BCG3021	19 990 F
200 x 200	BCG3024	24 995 F

RECTANGLE



Longueur 6 m - Épaisseur 1,5 mm		
Dimensions en mm	Réf.	PRIX
30 x 20	BRG1002	1 790 F
40 x 20	BRG1004	2 195 F
40 x 30	BRG1005	2 595 F
50 x 25	BRG1007	2 790 F

Longueur 6 m - Épaisseur 2 mm		
Dimensions en mm	Réf.	PRIX
50 x 30	BRG2008	3 040 F
60 x 30	BRG2009	3 996 F

Longueur 6 m - Épaisseur 3 mm		
Dimensions en mm	Réf.	PRIX
50 x 30	BRG3008	4 210 F
60 x 30	BRG3009	4 775 F
80 x 40	BRG3015	6 225 F
100 x 50	BRG3020	7 930 F
120 x 60	BRG3024	9 860 F
150 x 50	BRG3030	11 700 F
150 x 100	BRG3032	13 995 F
200 x 100	BRG3039	17 520 F

ROND



Longueur 6 m - mâle / femelle		
Ø en pouces	Réf.	PRIX
1/2	CG015	1 515 F
3/4	CG020	1 900 F
1	CG026	2 580 F
1"1/4	CG033	3 995 F
1"1/2	CG040	4 235 F
2	CG050	5 730 F
3	CG080	9 815 F
4	CG102	17 175 F

Longueur 6 m - lisse		
Ø en pouces	Réf.	PRIX
1/2	CG215	1 295 F
3/4	CG220	1 635 F
1	CG225	2 185 F
1"1/4	CG232	2 885 F
1"1/2	CG240	3 755 F
2	CG250	5 475 F
3	CG280	9 395 F
4	CG290	13 530 F

POSTE À SOUDER

SÉLECTION
SOMAC
MATÉRIAUX DE CONSTRUCTION



170 A

Poste à souder
Réf. AGE0359

24 990 F



170 A

Poste à souder
+ casque
Réf. IMS0009

34 995 F



140 A

Poste à souder
multiprocess
avec ou sans gaz
Réf. IMS0038

56 995 F

ACIER
INOX
ALU



TÔLE ALUMINUM



Tôle à damier alu
2,40 x 1,20 m - Épaisseur 1,6 mm
Réf. NAL0501

43 695 F

TUBE CARRÉ



Tube carré alu plein
12,7 x 12,7 mm - Longueur 5 m
Réf. NAL0401

10 395 F



Tube carré alu
40 x 40 mm
épaisseur 2 mm - longueur 5 m
Réf. NAL0201

18 995 F

CORNIÈRE ALUMINUM



Longueur 5 m

Dimensions en mm	Réf.	PRIX
12 x 12 x 1,6	NAL0003	2 495 F
12 x 20 x 1,6	NAL0004	3 195 F
12 x 25 x 1,6	NAL0006	3 595 F
20 x 20 x 1,6	NAL0005	3 995 F
20 x 32 x 1,5	NAL0001	4 895 F
20 x 40 x 1,6	NAL0007	5 995 F
25 x 65 x 3	NAL0010	17 294 F
40 x 40 x 1,6	NAL0008	8 094 F
50 x 50 x 1,5	NAL0002	9 495 F
50 x 50 x 3	NAL0009	18 695 F

CORNIÈRE ALUMINUM BLANC



Longueur 5 m

Largeur en mm	Réf.	PRIX
12 x 12 x 1,6	NAL0052	3 290 F
20 x 20 x 1,6	NAL0053	4 495 F
40 x 40 x 1,6	NAL0054	8 795 F
50 x 50 x 1,5	NAL0051	9 995 F

PROFILÉ ALUMINIUM

FER PLAT ALUMINUM



Longueur 5 m

Dimensions en mm	Réf.	PRIX
16 x 3	NAL0101	3 095 F
31,8 x 3,2	NAL0102	6 595 F
75 x 3	NAL0103	14 395 F

PROFILÉ U ALU



Longueur 5 m

Dimensions en mm	Réf.	PRIX
20 x 20 - Épaisseur 2,5 mm	NAL0302	5 995 F
22 x 12- Épaisseur 1,5 mm	NAL0301	4 195 F
22 x 22- Épaisseur 3 mm	NAL0304	11 494 F
40 x 20- Épaisseur 4 mm	NAL0303	14 295 F

TÔLE INOX



Dimensions 2,00 x 1,00 m		
Épaisseur en mm	Réf.	PRIX
0,60	WTI06	10 990 F
1,00	WTI10	18 595 F
1,50	WTI15	28 995 F
2,00	WTI20	33 995 F

TÔLE GALVA



Dimensions 2,00 x 1,00 m		
Épaisseur en mm	Réf.	PRIX
0,60	WTPG06	3 895 F
0,80	WTPG08	4 290 F
1,00	WTPG10	4 690 F
1,25	WTPG12	5 895 F
1,50	WTPG15	6 795 F
2,00	WTPG20	9 590 F
2,50	WTPG25	11 490 F
3,00	WTPG30	13 995 F
4,00	WTPG40	18 395 F

TÔLE ACIER NOIR

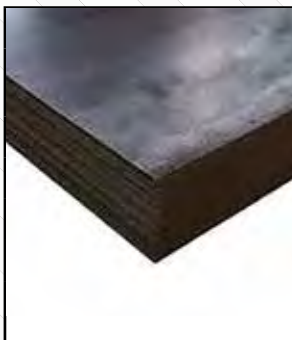

Dimensions 2,00 x 1,00 m		
Épaisseur en mm	Réf.	PRIX
1,5	BT015	5 995 F
2	BT020	7 295 F
3	BT030	11 395 F
4	BT040	14 095 F
Disponible jusqu'à 15 mm		

TÔLE LARMÉE NOIR



Épaisseur en mm	Dimension en cm	Réf.	PRIX
4/6	100 x 200	BTL46	16 995 F
	300 x 150	BTL47	37 990 F
5/7	100 x 200	BTL57	21 295 F
	300 x 150	BTL58	41 995 F

TAMIS GALVA



Dimensions 2,00 x 1,00 m			
Maille en mm	ø en mm	Réf.	PRIX
10	1,8	ETG10	5 200 F
20	2,7	ETG20	5 395 F
25	3,0	ETG25	4 295 F
30	3,4	ETG30	4 690 F
40	3,9	ETG40	4 795 F

METAL DEPLOYÉ GALVA



Dimensions 2,00 x 1,00 m			
Maille en mm	Épaisseur en mm	Réf.	PRIX
20 x 25	2	EMDG252	6 590 F
28 x 13	1,5	EMDG253	6 190 F
30 x 30	3	EMDG303	7 695 F
60 x 30	3	EMDG304	16 995 F
35 x 15	2	EMDG350	8 090 F
35 x 20	2	EMDG352	4 995 F
40 x 30	3	EMDG403	5 845 F
50 x 30	3	EMDG503	8 295 F



BOIS DE CONSTRUCTION

BOIS DE CHARPENTE



BOIS TRAITÉ 1 POUCE

Disponible en 3 tailles

- 1 x 3
- 1 x 6
- 1 x 12

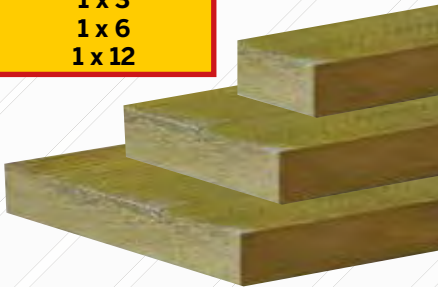

Section en pouces	Longueur en pieds	Réf.	PRIX
1 x 3	16	OT10316	937 F
	18	OT10318	1 049 F
	20	OT10320	1 154 F

Section en pouces	Longueur en pieds	Réf.	PRIX
1 x 6	12	OT10612	1 225 F
	14	OT10614	1 429 F
	16	OT10616	1 726 F
	18	OT10618	1 890 F
20	OT10620	2 227 F	

Section en pouces	Longueur en pieds	Réf.	PRIX
1 x 12	16	OT11216	3 823 F
	18	OT11218	4 239 F
	20	OT11220	4 872 F

Les prix des bois de construction sont à titre indicatif et fluctuent en fonction des arrivages.

BOIS TRAITÉ 2 POUCES



Section en pouces	Longueur en pieds	Réf.	PRIX
2 x 2	12	OT20212	696 F
	14	OT20214	807 F
	16	OT20216	822 F
	18	OT20218	926 F
	20	OT20220	1 037 F

Section en pouces	Longueur en pieds	Réf.	PRIX
2 x 3	10	OT20310	847 F
	12	OT20312	974 F
	14	OT20314	1 088 F
	16	OT20316	1 244 F
	18	OT20318	1 389 F
	20	OT20320	1 543 F
	22	OT20322	1 876 F
	24	OT20324	2 422 F

Section en pouces	Longueur en pieds	Réf.	PRIX
2 x 4	10	OT20410	982 F
	12	OT20412	1 123 F
	14	OT20414	1 331 F
	16	OT20416	1 546 F
	18	OT20418	1 768 F
	20	OT20420	1 964 F
	22	OT20422	2 808 F
	24	OT20424	2 691 F

POINT INFO

Mesure des pouces en cm

1 pouce	1,8 cm
2 pouces	3,8 cm
3 pouces	6,5 cm
4 pouces	9 cm
6 pouces	14 cm
8 pouces	19 cm
10 pouces	24 cm
12 pouces	29 cm

Mesure des pieds en mètre

10 pieds	3 m 05
12 pieds	3 m 66
14 pieds	4 m 27
16 pieds	4 m 88
18 pieds	5 m 49
20 pieds	6 m 10
22 pieds	6 m 71
24 pieds	7 m 32

Disponible en 7 tailles

2 x 2	2 x 4	2 x 8	2 x 12
2 x 3	2 x 6	2 x 10	

Section en pouces	Longueur en pieds	Réf.	PRIX
2 x 6	10	OT20610	1 496 F
	12	OT20612	1 670 F
	14	OT20614	1 965 F
	16	OT20616	2 339 F
	18	OT20618	2 694 F
	20	OT20620	2 993 F
	22	OT20622	4 313 F
	24	OT20624	4 120 F

Section en pouces	Longueur en pieds	Réf.	PRIX
2 x 8	14	OT20814	2 880 F
	16	OT20816	3 513 F
	20	OT20820	4 114 F
	24	OT20824	5 494 F

Section en pouces	Longueur en pieds	Réf.	PRIX
2 x 10	16	OT21016	4 331 F
	18	OT21018	4 872 F
	20	OT21020	5 413 F

Section en pouces	Longueur en pieds	Réf.	PRIX
2 x 12	12	OT21212	4 761 F
	14	OT21214	5 392 F
	16	OT21216	6 013 F
	18	OT21218	6 765 F
	20	OT21220	7 934 F
	22	OT21222	8 626 F
	24	OT21224	9 688 F



BOIS TRAITÉ 3 POUCES

Section en pouces	Longueur en pieds	Réf.	PRIX
3 x 3	12	OT30312	1 858 F
	14	OT30314	2 326 F
	16	OT30316	2 478 F
	18	OT30318	2 787 F
	20	OT30320	3 271 F
	22	OT30322	3 771 F
24	OT30324	3 884 F	

Section en pouces	Longueur en pieds	Réf.	PRIX
3 x 4	16	OT30416	3 118 F
	18	OT30418	3 717 F
	20	OT30420	4 014 F
	24	OT30424	5 568 F

Section en pouces	Longueur en pieds	Réf.	PRIX
3 x 6	12	OT30612	3 612 F
	14	OT30614	4 190 F
	16	OT30616	4 705 F
	18	OT30618	5 418 F
	20	OT30620	5 951 F
	22	OT30622	7 618 F
24	OT30624	7 350 F	

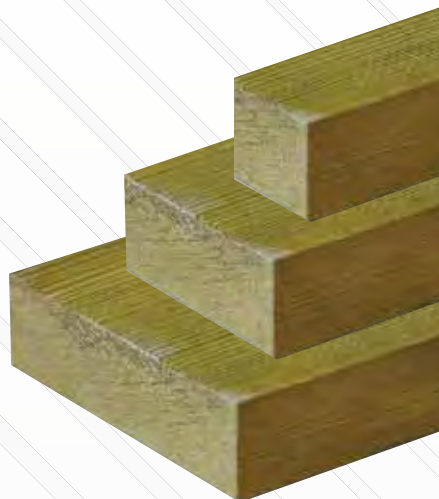

Section en pouces	Longueur en pieds	Réf.	PRIX
3 x 8	14	OT30814	6 171 F
	16	OT30816	7 053 F
	18	OT30818	7 934 F
	20	OT30820	8 398 F
	24	OT30824	9 744 F

BOIS TRAITÉ 4 POUCES



Section en pouces	Longueur en pieds	Réf.	PRIX
4 x 4	20	OT40420	4 826 F
4 x 6	20	OT40620	8 445 F
4 x 8	20	OT40820	11 074 F
4 x 10	24	OT41024	17 818 F

BOIS TRAITÉ 6 POUCES



Section en pouces	Longueur en pieds	Réf.	PRIX
6 x 6	20	OT60620	12 876 F

BOIS GRIFFÉ 2 POUCES ET 3 POUCES

Section en pouces	Longueur en pieds	Réf.	PRIX
2 x 3	20	OTG2320	2 146 F
2 x 4	20	OTG2420	2 149 F
3 x 6	20	OTG3620	7 378 F



ACCESSOIRE



SIMPSON
Strong-Tie

Sabot ailé T250
140 x H105
épaisseur 2
Réf. SIM1204



495 F



SIMPSON
Strong-Tie

Equerre renforcée
90 x 90
épaisseur 2,5
Réf. SIM1707



195 F



SIMPSON
Strong-Tie

Equerre assemblage
50 x 50
épaisseur 2
Réf. SIM1719

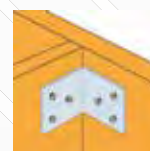

195 F



SIMPSON
Strong-Tie

Patte solivage
200 x 30
épaisseur 1,5
Réf. SIM2102



195 F



SIMPSON
Strong-Tie

Feuillard perforé
0,9 x 10 m
épaisseur 1,5
Réf. SIM2001



2 695 F



BOIS DE CONSTRUCTION



Les prix des bois de construction sont à titre indicatif et fluctuent en fonction des arrivages.

CONTRE PLAQUÉ BAKELISÉ 1,22 x 2,44 m		
Épaisseur en mm	Réf.	PRIX
NOIR		
15	PAN0503	4 350 F
18	PAN0502	5 200 F
MARRON		
15	PAN0507	5 150 F
18	PAN0506	5 995 F

BOIS ORDINAIRE 1 POUCE



Section en pouces	Longueur en pieds	Réf.	PRIX
1 x 12	16	0011216	2 840 F
	18	0011218	3 153 F
	20	0011220	3 503 F

BOIS ORDINAIRE 2 POUCES

Section en pouces	Longueur en pieds	Réf.	PRIX
2 x 3	12	0020312	773 F
	14	0020314	853 F
	16	0020316	993 F
	18	0020318	1 054 F
	20	0020320	1 172 F

Section en pouces	Longueur en pieds	Réf.	PRIX
2 x 4	14	0020414	996 F
	16	0020416	1 138 F
	18	0020418	1 281 F
	20	0020420	1 346 F
	24	0020424	1 485 F

Section en pouces	Longueur en pieds	Réf.	PRIX
2 x 6	12	0020612	1 322 F
	16	0020616	1 615 F
	18	0020618	1 984 F
	20	0020620	2 111 F



Section en pouces	Longueur en pieds	Réf.	PRIX
2 x 12	12	0021212	3 341 F
	14	0021214	3 898 F
	16	0021216	4 566 F
	18	0021218	5 304 F
	20	0021220	6 032 F
	22	0021222	6 635 F
	24	0021224	7 238 F

BOIS ORDINAIRE 3 POUCES

Section en pouces	Longueur en pieds	Réf.	PRIX
3 x 3	20	0030320	2 245 F
3 x 4	18	0030418	2 861 F
	20	0030420	3 062 F
3 x 6	14	0030614	2 923 F
	16	0030616	3 202 F
	20	0030620	4 246 F



BOIS DE COFFRAGE



Colle à bois D3
Bison
750 g - Réf. BIS0023
3 kg - Réf. BIS0024 - **4 995 F**
5 kg - Réf. BIS0025 - **7 895 F**

à partir de 1 995 F



PANNEAU OSB SMART PANEL

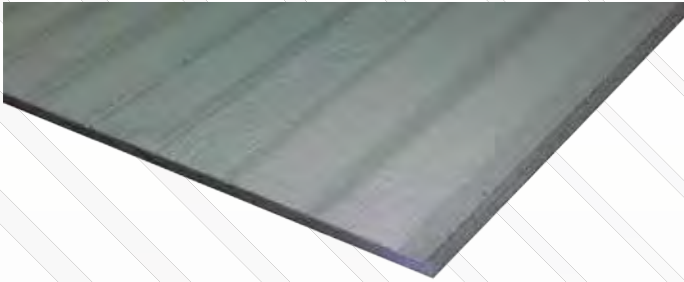

Dimension en m	Épaisseur en mm	Réf.	PRIX
1,22 x 2,44	11,1	PAN1251	8 795 F
1,22 x 3,00		PAN1252	11 795 F

CONTREPLAQUÉ RADIATA RAINURÉ



Dimension en m	Épaisseur en mm	Réf.	PRIX
1,22 x 2,44	12	PAN0702	8 995 F

CONTREPLAQUÉ MARINE MÉRANTI



Dimension en m	Épaisseur en mm	Réf.	PRIX
1,22 x 2,44	9	PAN0430	11 595 F
	12	PAN0431	15 195 F
	15	PAN0432	19 595 F
	18	PAN0433	22 795 F

CONTREPLAQUÉ MARINE OKOUMÉ



Dimension en m	Épaisseur en mm	Réf.	PRIX
1,22 x 2,44	6	PAN0440	6 995 F
	9	PAN0441	8 590 F
	12	PAN0442	10 490 F
	15	PAN0443	12 490 F
	18	PAN0444	14 390 F

CONTREPLAQUÉ OKOUMÉ



Dimension en m	Épaisseur en mm	Réf.	PRIX
1,22 x 2,44	3	PAN0206	1 390 F
	6	PAN0205	1 878 F
	9	PAN0204	2 495 F
	12	PAN0203	2 995 F
	15	PAN0202	3 790 F
	18	PAN0201	4 395 F



Scie à onglet
MS100L + support
230V -
Ø 254 mm
Réf. AGE1007

39 990 F



TOITURE

TÔLE PLASTIQUE

TÔLE PLASTIQUE
0,90 x 2,50 m
Épaisseur : 1 mm

2 495 F
l'unité



Incolore
Réf. TOL0203



Jaune
Réf. TOL0202



Vert
Réf. TOL0201

TÔLE POLYCARBONATE
0,85 x 3 m
Épaisseur : 0,8 mm

10 990 F
l'unité

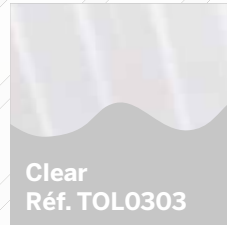

Clear
Réf. TOL0303

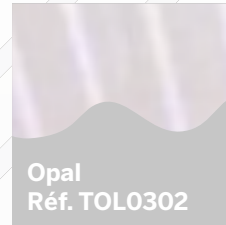

Opal
Réf. TOL0302



Bronze
Réf. TOL0301

TUILES ASPHALTÉES

TUILES ASPHALTÉES
ARMOURSHIELD

1 595 F
le m²



TUILES ASPHALTÉES
ARMOURGLASS

1 695 F
le m²

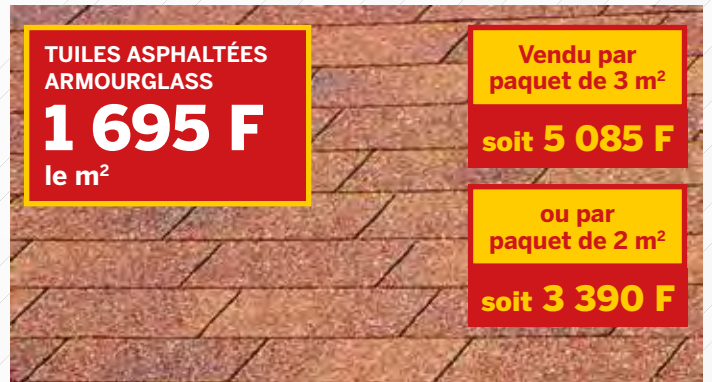

Vendu par
paquet de 3 m²

soit 5 085 F

ou par
paquet de 2 m²

soit 3 390 F



Rouge
Réf. IKO101

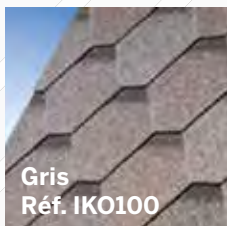

Gris
Réf. IKO100

Vendu par
paquet de 3 m²

soit 4 785 F

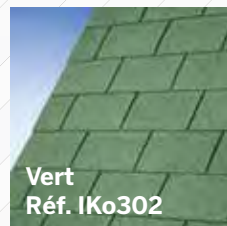

Vert
Réf. IKO302

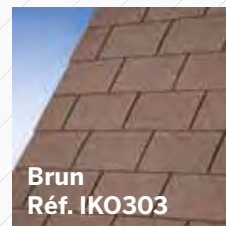

Brun
Réf. IKO303

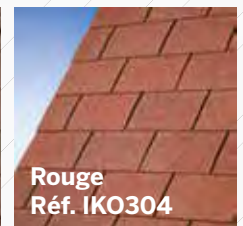

Rouge
Réf. IKO304

TUILES RED CEDAR

TUILES RED CEDAR

7 495 F
le m²



Réf. TUI0001

Vendu par
paquet de 1,85 m²

soit 13 866 F

FEUTRE ARMOURBASE

Pour tuiles
1 x 30 m
Réf. IKO500



8 995 F

COUVERTURE



AÉRATEUR ÉOLIEN

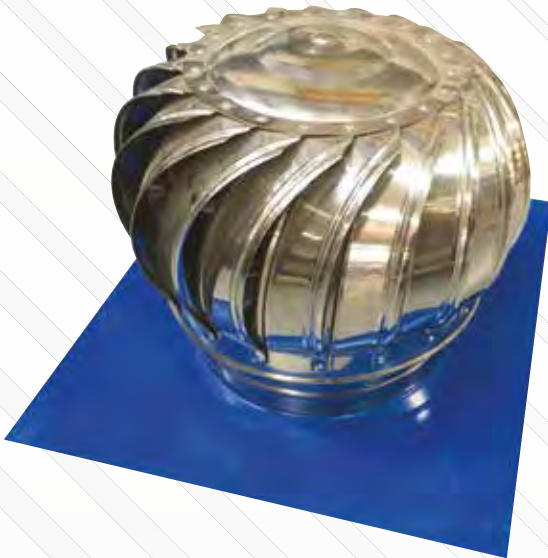

Diamètre en mm	Réf.	PRIX
300	SOME512	9 995 F
400	SOME514	18 995 F
490	SOME516	19 995 F
780	SOME506	49 995 F

MANCHON FLASH

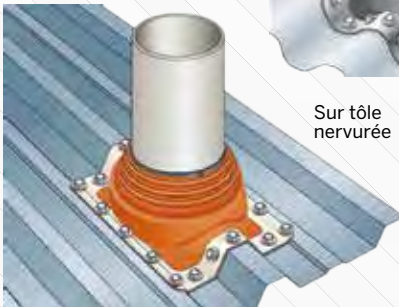
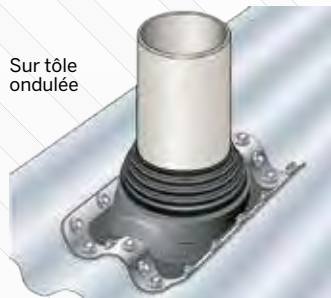

Manchons Flash

Tuyaux
 ø 6 - 50 mm
 Réf. FAY0400

2 895 F

ø 32 - 76 mm
 Réf. FAY0410

3 395 F

ø 6 - 102 mm
 Réf. FAY0420

4 895 F



Kit Fenoflash
 Mastic / Vis
 Réf. FAY0450

3 495 F

GOUTTIÈRE



Crapaudine
 G2 - 80 / 100
 Réf. FAY0510

650 F

Profil gouttière G33
 Longueur 4 m
 Gris
 Réf. NIC0031

4 930 F

Modèles disponibles en blanc

Crochet gouttière G33
 Gris
 Réf. NIC0039

465 F



Naissance centrale G33
 Gris
 Réf. NIC0034

1 915 F



Colle gel PVC GEB
 1 litre, avec pinceau
 Réf. NIC1503

1 995 F



PANNEAU LISSE



Fibrociment lisse 1,22 x 2,44 m		
Épaisseur en mm	Réf.	PRIX
4,5	PAN1004	1 790 F
6	PAN1003	2 595 F
9	PAN1002	3 290 F
12	PAN1001	4 995 F
20	PAN1000	7 995 F

Amroc B1 1,20 x 2,50 m		
Épaisseur en mm	Réf.	PRIX
8	PAN1304	4 895 F
10	PAN1303	5 595 F
12	PAN1302	7 150 F
18	PAN1301	10 895 F

CLOISON FIBROCIMENT

CLIN



Motif	Dim.	Ép.	Réf.	PRIX
Cassia	300 x 20 cm	8	PAN1202	985 F
Woodgrain	420 x 23 cm	7,5	PAN1203	1 150 F
	420 x 30 cm		PAN1204	1 595 F
Jakaranda	300 x 15 cm	10	PAN1201	1 795 F

PANNEAU

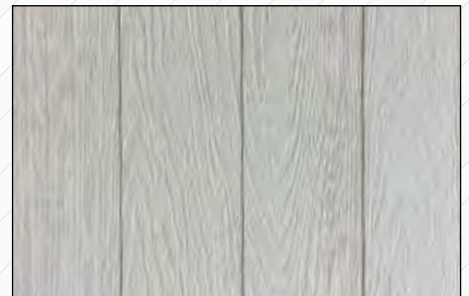

Panneau fibrociment Cassiano rainuré
122 x 244 - Épaisseur 6 mm
Réf. PAN1102

3 750 F

ACCESSOIRE CLIN



Angle extérieur alu
23 cm - Réf. PAN1218
30 cm - Réf. PAN1219

495 F



Angle intérieur alu
23 cm - Réf. PAN1220
30 cm - Réf. PAN1221

495 F



Joint PVC pour clin
23 cm
Réf. PAN1215

195 F



LAMBRIS BOIS



Lambris pin sans nœud
Lame de 2 m x 10 cm
Épaisseur 10 mm
Réf. LAM0012

Vendu par
paquet de
2 m²

2 685 F m²



Lambris pin déclassé
Lame de 2 m x 10 cm
Épaisseur 10 mm
Réf. LAM0011

Vendu par
paquet de
2 m²

975 F m²



Lambris radiata
Lame de 2,70 m x 14 cm
Épaisseur 12 mm
Réf. LAM0101

Vendu
à la lame
1 321 F

3 495 F m²

**Grille +
moustiquaire**
Blanc
22,6 x 32,3 mm
Réf. NIC0257



3 995 F

**Grille +
moustiquaire**
Blanc
Ø 125 mm
Réf. NIC0252



1 095 F

**Clouteur
pneumatique**
Pour clous de
15 à 50 mm
Réf. RAP0042



11 990 F

LAMBRIS PVC



Lambris PVC blanc
Lame de 6 m x 12 cm
Épaisseur 10 mm
Réf. LAM0008

Vendu par
paquet de
7,2 m²

9 295 F



Lambris PVC blanc
Lame de 6 m x 24 cm
Épaisseur 10 mm
Réf. LAM0006

Vendu par
paquet de
7,2 m²

11 250 F

Jonction H pour lambris PVC
Longueur 6 m
Réf. LAM0009

995 F

**Bordure U
pour lambris
PVC**
Longueur 6 m
Réf. LAM0010



795 F



PANNEAU DE CONSTRUCTION

CONTREPLAQUÉ IMITATION

Noble
Réf. PAN0612

1,22 x 2,44 m
Épaisseur : 3,2 mm
2 595 F
la feuille

White Teak
Réf. PAN0613

Rosa Teak
Réf. PAN0614

African Teak
Réf. PAN0615

Elmy
Réf. PAN0616

Universal Cherry
Réf. PAN0617

Honey Pine
Réf. PAN0618

Natural Oak
Réf. PAN0619

Kadi Weave
Réf. PAN0620

Italian Pine
Réf. PAN0621

St-Louis Birch
Réf. PAN0622

Sheldan Pecan
Réf. PAN0623

PANNEAU IMITATION

PINEX

PINEX À MOTIF
1,22 x 2,44 m • Épaisseur : 4,5 cm
2 595 F la feuille

Wood grain A
Réf. PAN0110

Rainure Wood
grain B
Réf. PAN0111

Macot Cloud
Réf. PAN0113

Elephant Hyde
Réf. PAN0112

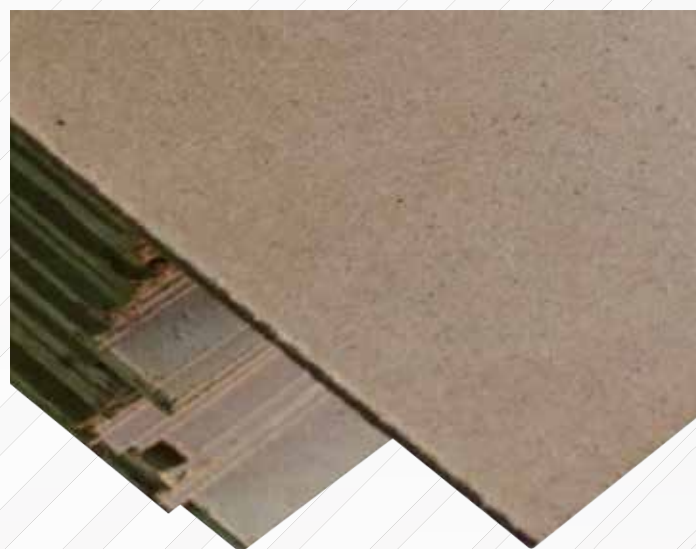

PINEX STANDARD • FACE LISSE

Dimension en m	Épaisseur en mm	Réf.	PRIX
1,22 x 2,40	3,2	PAN0104	970 F
	4,5	PAN0103	1 366 F



PANNEAU ANTI-TERMITE TERMIFLOR

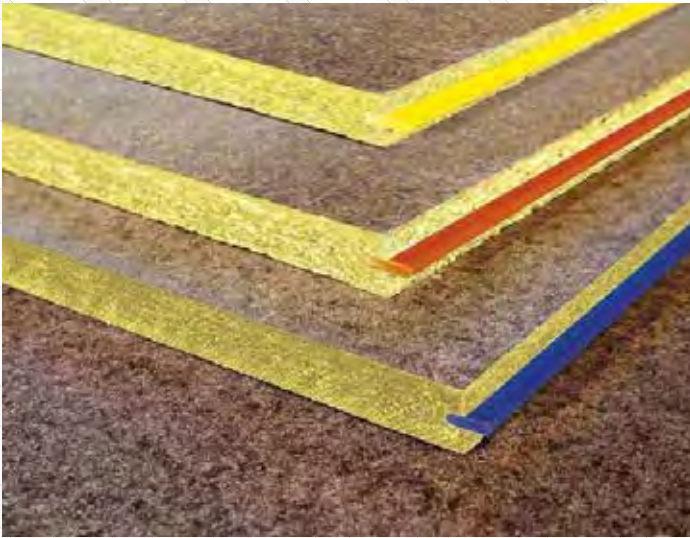

Panneau TERMIFLOR • 0,90 x 3,60 m

Coloris	Épaisseur en mm	Réf.	PRIX
Jaune	19	PAN1402	10 990 F
Rouge	22	PAN1401	11 990 F

CONTREPLAQUÉ RADIATA TRAITÉ



Contreplaqué Radiata traité • 1,22 x 2,44 m

Épaisseur en mm	Réf.	PRIX
7	PAN0310	4 415 F
9	PAN0309	4 795 F
12	PAN0308	6 510 F
15	PAN0307	7 995 F
18	PAN0306	9 770 F

ISOREL PANNEAU ISOLANT TABLEAU D'AFFICHAGE



Panneau isolant
ISOREL
120 x 250 cm
épaisseur 1,9 cm
Réf. PAN0100

FIXATION



Clou galva tête plate
80 mm - Boîte de 1 kg
Réf. ECPG081



995 F

5 860 F



MOULURE BOIS

LONGUEUR 2,90 m

TASSEAU PIN



Dimension en mm	Réf.	PRIX
10 x 30	LEV0100	595 F
10 x 40	LEV0101	695 F
10 x 50	LEV0102	970 F
14 x 20	LEV0103	495 F
14 x 30	LEV0104	775 F
14 x 40	LEV0105	995 F
14 x 50	LEV0106	995 F
17 x 30	LEV0107	875 F

Dimension	Réf.	PRIX
17 x 40	LEV0108	995 F
17 x 50	LEV0109	1 295 F
23 x 30	LEV0110	1 075 F
23 x 40	LEV0111	1 375 F
23 x 50	LEV0112	1 645 F
35 x 30	LEV0150	1 895 F

CARRELET PIN



Dimension en mm	Réf.	PRIX
10 x 10	LEV0090	220 F
14 x 14	LEV0091	445 F
17 x 17	LEV0092	575 F
23 x 23	LEV0093	970 F
28 x 28	LEV0094	1 295 F
35 x 35	LEV0151	1 980 F

PLINTHE PIN



Dimension en mm	Réf.	PRIX
10 x 50	LEV0080	995 F
10 x 70	LEV0081	1 375 F
10 x 100	LEV0082	1 795 F

BAGUETTE ANGLE PIN



Dimension en mm	Réf.	PRIX
15 x 15	LEV0001	575 F
18 x 18	LEV0002	695 F
23 x 23	LEV0003	745 F
28 x 28	LEV0004	995 F

1/4 ROND PIN



Dimension en mm	Réf.	PRIX
12	LEV0020	295 F
14	LEV0021	390 F
17	LEV0022	575 F
20	LEV0023	745 F
23	LEV0024	991 F
28	LEV0025	1 340 F

1/2 ROND PIN



Dimension en mm	Réf.	PRIX
17	LEV0030	470 F
23	LEV0031	595 F

TOURILLON PIN



Dimension en mm	Réf.	PRIX
12	LEV0010	575 F
14	LEV0011	595 F
20	LEV0012	745 F
23	LEV0013	970 F
28	LEV0014	1 395 F

CHANT PLAT 1 AR PIN



Dimension en mm	Réf.	PRIX
6 x 25	LEV0046	325 F
6 x 35	LEV0047	425 F
8 x 35	LEV0048	575 F
8 x 50	LEV0049	945 F

CHANT PLAT 2 AR PIN



Dimension en mm	Réf.	PRIX
5 x 20	LEV0040	275 F
6 x 25	LEV0041	325 F
6 x 35	LEV0042	425 F
8 x 35	LEV0043	575 F
8 x 50	LEV0044	875 F
10 x 50	LEV0045	995 F

CHAMBRANLE PIN



Modèle	Dim. en mm	Réf.	PRIX
A	10 x 40	LEV0060	775 F
	10 x 50	LEV0061	970 F
AR	10 x 40	LEV0062	695 F
	10 x 50	LEV0063	945 F
B	10 x 40	LEV0064	695 F
	10 x 50	LEV0065	945 F

MOULURE PIN

MOULURE BOIS

LONGUEUR 2,40 m



TASSEAU



Dimension en mm	Réf.	PRIX
10 x 40	LEV0214	1 245 F
14 x 40	LEV0215	1 745 F

BAGUETTE ANGLE



Dimension en mm	Réf.	PRIX
15 x 15	LEV0209	795 F
18 x 18	LEV0210	925 F
23 x 23	LEV0211	1 395 F
28 x 28	LEV0212	1 775 F

PLINTHE

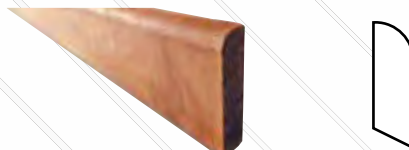

Dimension en mm	Réf.	PRIX
10 x 70	LEV0201	2 245 F

1/4 ROND



Dimension en mm	Réf.	PRIX
17	LEV0205	945 F
20	LEV0206	1 275 F
23	LEV0207	1 495 F
28	LEV0208	1 980 F

CHANT PLAT 2AR



Dimension en mm	Réf.	PRIX
5 x 20	LEV0202	425 F
6 x 25	LEV0203	470 F
6 x 35	LEV0204	725 F

CHANT PLAT 1AR



Long. 2,90

Dimension en mm	Réf.	PRIX
10 x 50	LEV6009	995 F
10 x 70	LEV6001	1 285 F
10 x 90	LEV6002	1 645 F

PLAN DE TRAVAIL

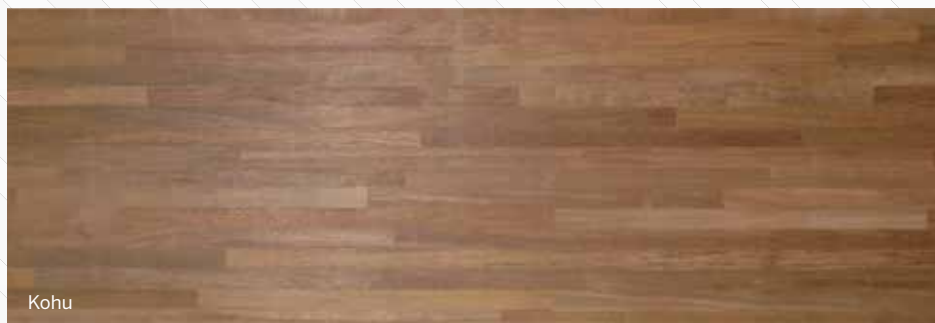

Kohu • 3,5 x 65 cm

Longueur en m	Réf.	PRIX
2,44	LEV6003	34 995 F
3,05	LEV6004	44 995 F
3,66	LEV6005	54 990 F

Radiata • 3,1 x 63 cm

Longueur en m	Réf.	PRIX
2,30	LEV6011	19 995 F



Tréteau hêtre
Hauteur 75 cm
Réf. LEV3006

1 595 F



Tréteau pin
Hauteur 75 cm
Réf. LEV3005

995 F



Scie circulaire
DEWALT
jusqu'à 67 mm
d'épaisseur
Réf. DEW0558

29 995 F

MOULURE BOIS ROUGE

PLAN DE TRAVAIL



PANNEAU

PLAQUE DE PLÂTRE



Plaque de plâtre 2,60 x 1,20 / Ép. 12,5 mm

Désignation	Réf.	PRIX
Standard	FIBR001	2 095 F
Eau	FIBR002	3 290 F
Feu	FIBR003	3 095 F

RÉPARATION

ENDUIT À PLÂTRE

Enduit de rebouchage lissage française SEMIN
5 kg - Réf. SEM5002
15 kg - Réf. SEM5003
6 895 F



à partir de 2 850 F

Enduit de rebouchage lissage Sem light SEMIN
1 kg - Réf. SEM5006
5 kg - Réf. SEM5007 - **7 390 F**



à partir de 1 495 F

Plâtre polyvalent SEMIN
Sac 25 kg
Réf. SEM3009



2 790 F

Plâtre facilis Lutece SEMIN
Sac 25 kg
Réf. SEM3012



3 390 F

TRAITEMENT DES JOINTS

Enduit pour joints CE78 SEMIN
5 kg - Réf. SEM1005
25 kg - Réf. SEM1006 - **3 995 F**



à partir de 1 395 F

Enduit pour joints stucco JF60
10 kg - Réf. FIBR010



2 995 F

Enduit pour joints stucco JF120
10 kg - Réf. FIBR011



2 995 F

Enduit pour joints JF Readymix
20 kg - Réf. FIBR012



7 590 F

Bande papier pour joint plaque de plâtre
Rouleau 23 m - Réf. TPLA546
Rouleau 150 m
Réf. TPLA545 - **795 F**



à partir de 260 F

Bande papier armée pour angle plaque de plâtre
Rouleau 30 m - Réf. TPLA540



1 695 F

Bande adhésive pour joint plaque de plâtre
Rouleau 50 m - Réf. PLA0040
Rouleau 153 m
Réf. PLA0041 - **3 090 F**



à partir de 1 390 F

Vis SEMIN pour plaque de plâtre
Boîte de 1 000
3,5 x 25 mm - Réf. SEM2001
3,5 x 35 mm
Réf. SEM2002 - **2 195 F**
3,5 x 45 mm
Réf. SEM2003 - **2 595 F**



à partir de 1 595 F



OSSATURE POUR CLOISON

NF



Rail galva
48 mm x 3 m - Réf. TPLA501
70 mm x 3 m - Réf. TPLA502 - **795 F**

à partir de **495 F**



Montant galva
48 mm x 2,6 m - Réf. TPLA520
70 mm x 3 m - Réf. TPLA521 - **890 F**

à partir de **595 F**

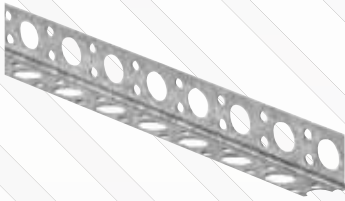

Cornière alu perforé
23,5 x 23,5 cm
épaisseur 0,35 mm
longueur 3 m - Réf. TPLA544

290 F



Agrafeuse pour profilés
TALIAPLAST
Réf. TAL0302

7 995 F



OSSATURE POUR PLAFOND

NF



Fourrure galva
45 mm x 530 cm - Réf. TPLA530
47 mm x 530 cm - Réf. TPLA531

à partir de **890 F**



Lisse galva
45/47 mm x 300 cm
Réf. TPLA532

495 F



Raccord éclipse pour fourrure
45/47 - Réf. TPLA541

30 F



Cavalier pivot pour fourrure
F45/47 - Réf. TPLA542

20 F

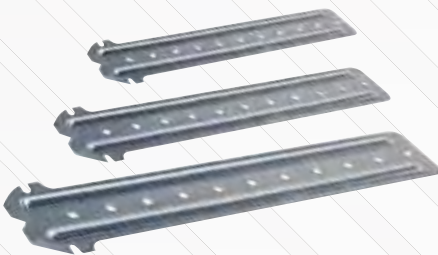
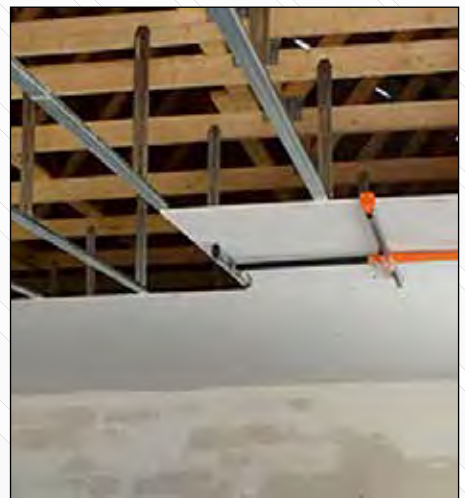

Suspente F45/47 pour poutre en bois
9 cm - Réf. TPLA547
24 cm - Réf. TPLA548 - **45 F**
40 cm - Réf. TPLA549 - **75 F**

à partir de **15 F**

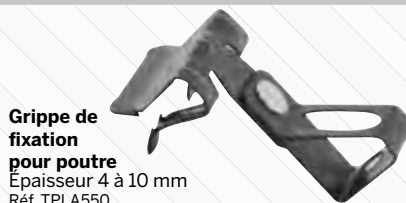

Grippe de fixation pour poutre
Épaisseur 4 à 10 mm
Réf. TPLA550

145 F



Tige filetée inox
Ø 6 mm - Longueur 1 m
Réf. ETIF106

360 F

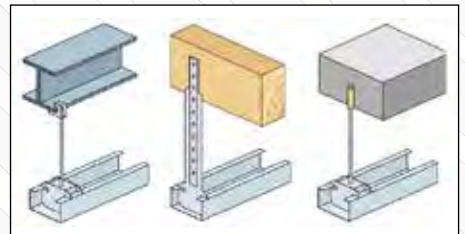

Cheville laiton
Ø 6 mm - Boîte de 100
Réf. FIS0351

5 990 F

ACCESSOIRE PLAQUE DE PLÂTRE



ISOLATION

ISOLATION SOUS TOITURE



Isolant mince à bulle MI
Épaisseur 8 mm
Rouleau de 1,25 x 24 m - Soit 30 m²
Réf. TALU008

25 990 F



Isolant mince à bulle
Épaisseur 7 mm
Rouleau de 1,50 x 20 m
Soit 30 m²
Réf. LEV7101

19 995 F



Isolant mince aluminium ANTIBLAZE
Rouleau de 1,35 x 60 m
Soit 81 m²
Réf. TALU0004

17 395 F



Isolant mince aluminium DURAFOIL
Rouleau de 1,35 x 60 m
Soit 81 m²
Réf. TALU003

13 995 F

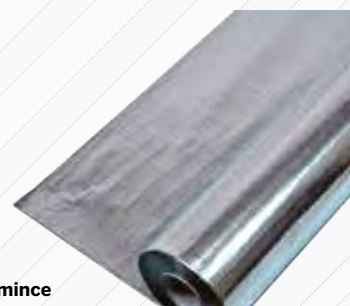

Isolant mince aluminium
Double face - Rouleau de 1,25 x 60 m
Soit 75 m²
Réf. TALU002

10 990 F

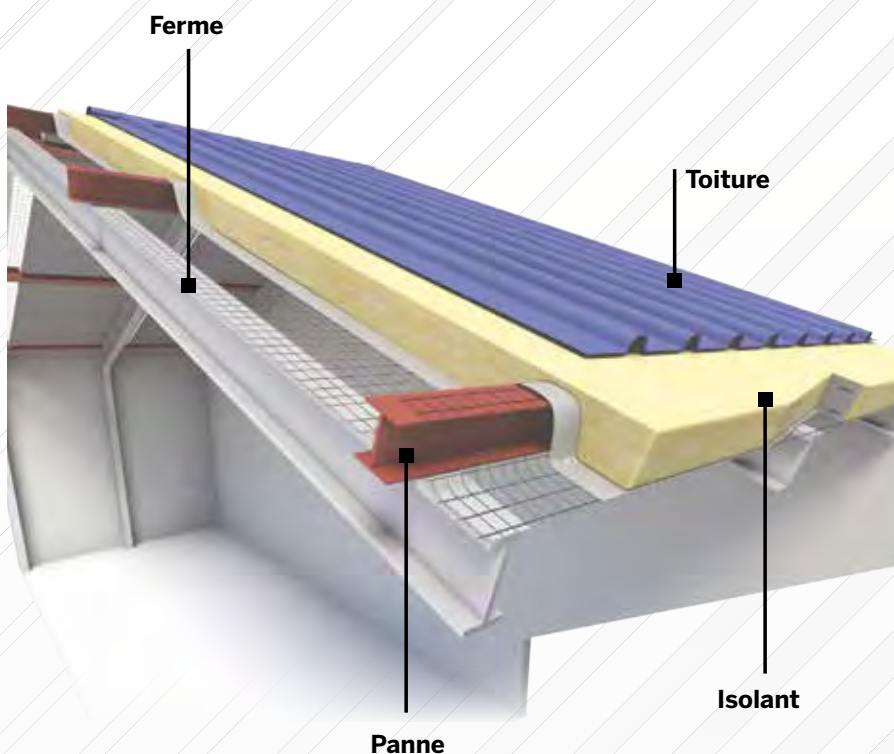

ISOLANT RÉFLECTIF

LAINES DE VERRE



Feutre tendu Alu / Laine de verre
Rouleau de 1,2 x 15 m - Soit 18 m²

Épaisseur en cm	Réf.	PRIX
5	ISO0101	11 990 F
8	ISO0102	16 250 F



Feutre tendu Alu blanc / Laine de verre
Rouleau de 1,2 x 15 m - Soit 18 m²

Épaisseur en cm	Réf.	PRIX
5	ISO0111	18 495 F
8	ISO0112	21 495 F

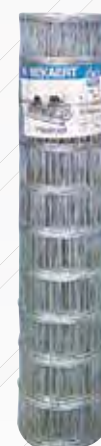

Grillage en treillis galva PLASTINET
Soudure galvanisée pour feutre tendu
Rouleau de 1,25 x 100 m
Soit 125 m²
Réf. ISO0103

28 990 F



ISOLATION PLAFOND

Laine de verre IBRNU

Dimension du rouleaux en m	Épaisseur en cm	Surface m ²	Réf.	PRIX
1,20 x 12 m	6	14,4	IS00001	8 990 F
1,20 x 9 m	8	10,8	IS00002	6 995 F

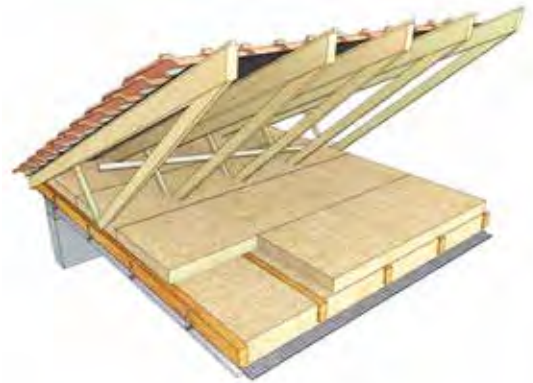

LAINE DE VERRE

ISOLATION CLOISON



Laine de roche URSA
épaisseur : 8 cm
Rouleau de 1,2 x 11 m
Soit 13 m²
Réf. TILR104

12 995 F



Laine de roche URSA
Lot de 2 rouleaux de
0,60 x 8,1 m - Soit 9,72 m²
Épaisseur 6,5 cm
Réf. TILR103

9 490 F



Laine de roche ROCKWOOL
Rouleau de 1,20 x 8 m - Soit 9,6 m²
Épaisseur 6 cm
Réf. TILR101

9 295 F



Laine de verre PARPHONIC TECH
Lot de 2 rouleaux de
0,9 x 5,4 m - Soit 10,80 m²
Épaisseur 6 cm
Réf. IS00059

7 395 F



Laine de verre PARPHONIC TECH
Lot de 2 rouleaux de
0,9 x 13 m - Soit 11,70 m²
Épaisseur 4,5 cm
Réf. IS00057

6 495 F



Laine de verre PARCONFORT
Lot de 2 rouleaux de
0,60 x 15,60 m
Épaisseur 45 mm
Réf. IS00056

6 990 F



Plaque de laine de verre GR32NU
Lot de 8 plaques de
1,35 x 0,60 m - Épaisseur 10 cm
Réf. IS00060

7 495 F



Mousse expansive polyuréthane
500 ml
Réf. FIS0341

1 595 F

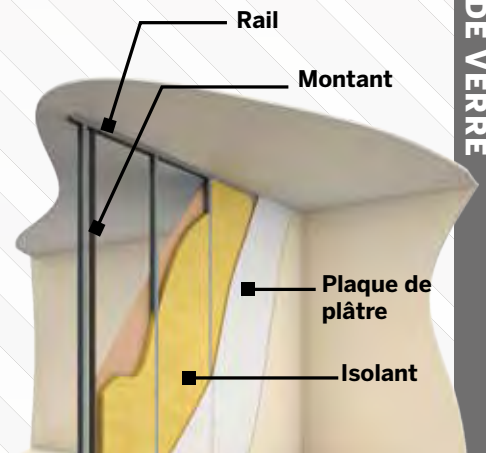

LAINE DE ROCHE

LAINE DE VERRE



TABLEAU ÉLECTRIQUE

COFFRET

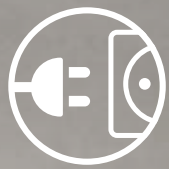

Drivia

Désign.	Réf.	PRIX
1 x 13 modules	ELO1118 +ELO1124	8 990 F
2 x 13 modules	ELO1121 +ELO1127	10 790 F
3 x 13 modules	ELO1122 +ELO1129	12 590 F



Plexo IP65

Désign.	Réf.	PRIX
1 x 2 modules	ELO1132	6 995 F
1 x 4 modules	ELO1135	8 295 F
1 x 6 modules	ELO1138	9 995 F
1 x 8 modules	ELO1141	9 995 F
1 x 12 modules	ELO1144	14 390 F
2 x 12 modules	ELO1147	26 990 F

DISJONCTEUR



Disjoncteur DNX3 2P

Ampère	Réf.	PRIX
10 A	ELO1160	1 890 F
16 A	ELO1163	1 995 F
20 A	ELO1166	1 595 F
25 A	ELO1169	2 195 F
32 A	ELO1173	2 290 F

INTER DIFFÉRENT

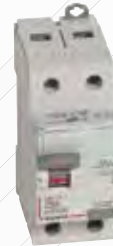

Inter différent AC2P

Ampère	Réf.	PRIX
25 A	ELO1180	7 890 F
40A	ELO1183	8 395 F

Inter différent A2P

Ampère	Réf.	PRIX
40 A	ELO1186	7 190 F
63 A	ELO1184	24 590 F

REPARTITEUR



Répartiteur bipolaire 100A
4 modules
Réf. ELO1261

3 695 F

TABLEAU ÉLECTRIQUE

INTER TEMPS



Inter horaires
50/60 Hz, digital, 2 modules
Réf. ELO1210

27 990 F



Inter journalier
50/60 Hz, 1 module
Réf. ELO1213

17 995 F

ACCESOIRES



Peigne vertical
pour coffret
2 x 13 modules
Réf. ELO1253
3 x 13 modules
Réf. ELO1256 - 995 F

À partir de 695 F

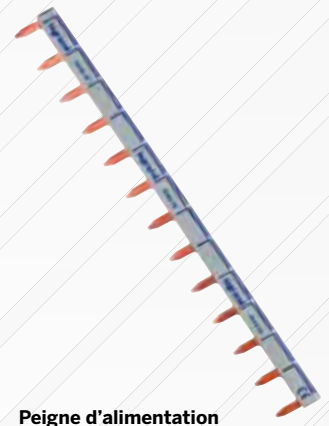

Peigne d'alimentation
Pour 13 module
Réf. ELO1250

745 F

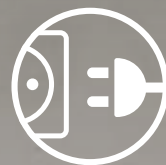

MISE À LA TERRE



Câble cuivre nu
25 mm²
Réf. ELO6183

495 F / ml



Piquet de terre 1 m
Réf. ELO1406

1 295 F



Barette de terre basse
Réf. ELO1403

3 290 F



1,5 mm²
éclairage

2,5 mm²
prise

Couronne de câble électrique rigide RO2V
3G, 1,5 mm², 50 m- Réf. ELO6321
3G, 2,5 mm², 50 m- Réf. ELO6327
7 995 F

À partir de 5 995 F

CABLE D'ALIMENTATION RIGIDE

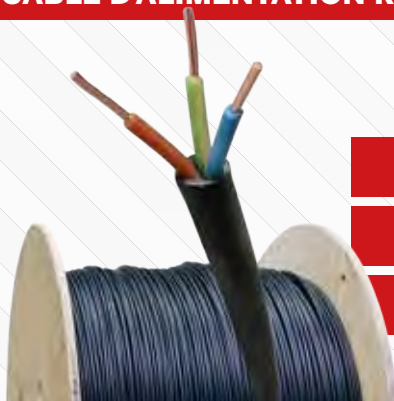

1,5 mm² éclairage

2,5 mm² prise

4 mm² lave-linge, four

Câble vendu au ml

Nombre de fil	Section mm ²	Réf.	PRIX
3G	1,5	ELO6324	130 F
	2,5	ELO6330	175 F
	4	ELO6333	340 F



Couronne de câble électrique rigide RO2V
5G, 1,5 mm², 50 m- Réf. ELO6353
5G, 2,5 mm², 50 m- Réf. ELO6356
15 995 F

À partir de 10 595 F

CABLE D'ALIM. SOUPLE



Couronne de câble électrique souple VVF
3G, 1,5 mm², 50 m- Réf. ELO6209
3G, 2,5 mm², 50 m- Réf. ELO6212
11 395 F

À partir de 8 995 F

CÂBLE TECHNIQUE



Câble antenne
17 AVTC
Réf. ELO6403

45 F / ml



Câble OPT PPT298
4 paires, ivoire
Réf. ELO6409

80 F / ml



Câble PPT92 2P
0,6, noir
spécial extérieur
Réf. ELO6406

85 F / ml



Couronne de câble unifilaire souple VVF
1,5 mm², 100 m
Vert/jaune - Réf. ELO6103
Bleu - Réf. ELO6106
Rouge - Réf. ELO6109

Disponible en 2,5 mm² et 4 mm²

3 895 F

CÂBLE D'ALIMENTATION



LES ENSEMBLES WC

WC CHANTIER



Ø d'évacuation
102 mm

**Pack WC
Appolon**
Sortie verticale - entraxe 220 mm
Réf. CEN1002

14 495 F

COLLECTION ULYSSE



Ø d'évacuation
102 mm
fourni avec kit
de fixation

PORCHER
La confiance installée

Pack WC Ulysse
Sortie verticale - entraxe 110 mm
Réf. IDE3041
Sortie horizontale - entraxe 185 mm
Réf. IDE3040

25 990 F

ULYSSE SURELEVE



Ø d'évacuation
102 mm
fourni avec kit
de fixation

PORCHER
La confiance installée

Pack WC Ulysse surélevé
Sortie horizontale - entraxe 185 mm
Réf. IDE3042
Hauteur d'assise 45 cm hors abattant,
47 cm avec abattant

29 995 F

WC HERCULE



Ø d'évacuation
102 mm

PORCHER
La confiance installée

WC Hercule
Sortie horizontale - entraxe 185 mm
+ abattant frein de chute
Réf. IDE3060

29 995 F

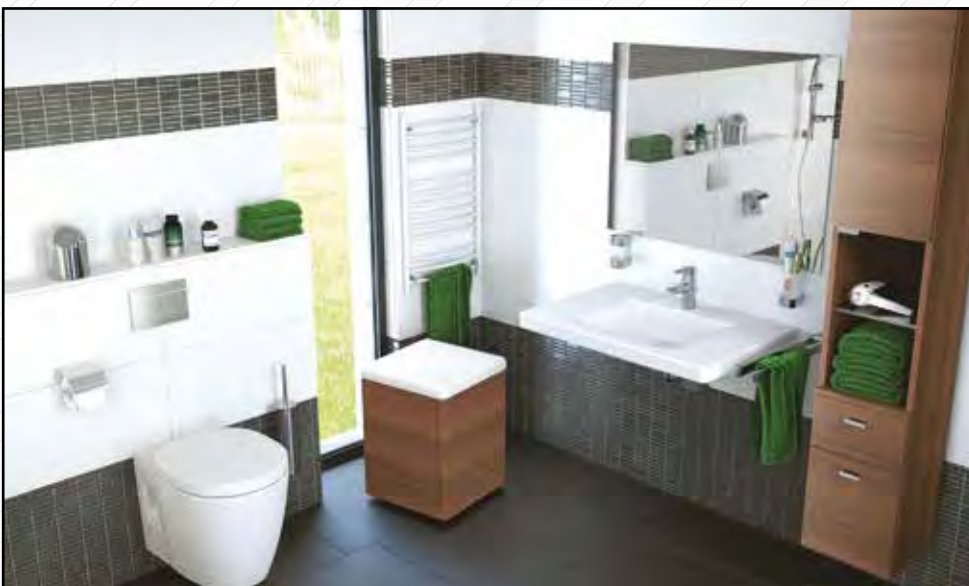

COLLECTION KHEOPS

Ø d'évacuation
102 mm
fourni avec kit
de fixation

**SÉLECTION
SOMAC**
MATÉRIEL DE CONSTRUCTION

Ideal
STANDARD

**Pack WC
Khéops+**
Sortie verticale
entraxe 215 mm
Réf. IDE3021
Sortie horizontale
entraxe 190 mm
Réf. IDE3020

34 995 F

COLLECTION CONNECT CUBE



Ø d'évacuation
102 mm
fourni avec kit
de fixation

Ideal
STANDARD

Pack WC Connect Cube
Sortie verticale - entraxe 205 mm
Réf. IDE3002
Sortie horizontale - entraxe 190 mm
Réf. IDE3001

39 990 F

COLLECTION CONNECT ARC



Ø d'évacuation
102 mm
fourni avec kit
de fixation

Ideal
STANDARD

Pack WC Connect Arc
Sortie verticale - entraxe 205 mm
Réf. IDE3004 - IDE3005 - IDE3006
Sortie horizontale - entraxe 190 mm
Réf. IDE3003 - IDE3005 - IDE3006

49 995 F

WC SUSPENDU

PORCHER

La confiance installée

Bâti-support réservoir encastré

Kit comprenant 1 système de fixation de la pipe (breveté)

1 réservoir isolé contre le bruit et la condensation (capacité maxi 9 L)

1 robinet flotteur silencieux NF

1 pipe et robinet d'évacuation

Épaisseur de l'habillage décoratif de 15 à 70 mm

Réglage de la cuvette en hauteur, entraxe de la cuvette 180 à 230 mm

Châssis conçu pour une résistance à une charge de 400 Kg conformément à la norme XP D12-20008 NF

Garantie anti-corrosion

Réglage individuel des pieds en hauteur

Dimensions :

(H) 1095 à 1330 x (l) 420 x (P) 150 mm

Poids du bâti : 21 Kg - Réf. IDE3201



29 995 F

Ø d'évacuation
102 mm



Cuvette suspendue Ulysse

Entraxe recommandé

220 mm de hauteur

rebord arrière anti-infiltration

Spécial collectivités - Réf. IDE3260



Abattant universel - Réf. IDE3050

9 995 F

4 995 F

Ø d'évacuation
102 mm



Cuvette suspendue Khéops

Entraxe recommandé

220 mm de hauteur

Réf. IDE3240



Abattant universel - Réf. IDE3050

18 995 F

4 995 F

Ø d'évacuation
102 mm

PORCHER

La confiance installée

Cuvette suspendue Connect Ideal Standard

Cuvette carénée (nettoyage facile)

Entraxe recommandé

220 mm de hauteur

Réf. IDE3220



Abattant Connect - Réf. IDE3006

24 990 F

6 495 F

Plaque de commande



Plaque de commande 395

B. rond Velvet chrome Nicoll

Réf. IDE3202

4 995 F



Plaque de commande 381

B. goutte Velvet chrome Nicoll

Réf. IDE3205

4 995 F



Plaque de commande BATI

Support blanc Ideal Standards

Réf. IDE3204

5 995 F



Plaque de commande BATI

Support CHR P2461AA

Réf. IDE3203

5 995 F

Ø d'évacuation
102 mm



+ propre
+ silencieux
+ intelligent

Cuvette suspendue Connect Aquablade

Cuvette carénée (nettoyage facile)

Chasse d'eau révolutionnaire AquaBlade

Entraxe recommandé

220 mm de hauteur

Réf. IDE3221



Abattant Connect - Réf. IDE3006

37 510 F

6 495 F

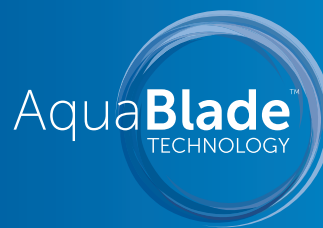

SYSTÈME DE CHASSE D'EAU RÉVOLUTIONNAIRE ET ULTRA PERFORMANT !

Performance optimale

Une surface rincée supérieure à 90% grâce à une chasse d'eau propulsée du haut de la cuvette

Hygiène et propreté impeccable

L'absence de bride saillante réduit la prolifération des bactéries l'entretien est facilité pour une propreté impeccable

Design moderne

Lignes pures et élégantes



Catalogue disponible sur demande

COLLECTION ULYSSE

COLLECTION KHEOPS

CONNECT AQUABLADE



LAVE-MAIN ET LAVABO

LAVE-MAIN

CARRÉ



Lave-main ELF
Porcelaine vitrifiée, 50 x 23,5 cm
Percé P169101 - Réf. IDE2459
Non Percé P169001 - Réf. IDE2460

NF

PORCHER
La confiance installée

9 495 F



Lave-main ULYSSE E898501
Porcelaine vitrifiée, 35 x 26 cm
Réf. IDE2421

NF

iSideal
STANDARD

5 290 F



Lave-main CONNECT ARC
Porcelaine vitrifiée, 35 x 26,5 cm
Droite E791301 - Réf. IDE2401
Gauche E791201 - Réf. IDE2402

NF

iSideal
STANDARD

14 790 F

LAVE-MAIN D'ANGLE



Lave-main d'angle ULYSSE E899701
Porcelaine vitrifiée
34 x 34 x 44 cm
Réf. IDE2463

NF

PORCHER
La confiance installée

7 690 F



Lave-main d'angle MATURA U220501
Porcelaine vitrifiée
34 x 34 x 47 cm
Réf. IDE2462

NF

PORCHER
La confiance installée

11 895 F



Lave-main d'angle CONNECT E713601
Porcelaine vitrifiée
34 x 34 x 44 cm
Réf. IDE2403

NF

iSideal
STANDARD

14 490 F

LAVABO

ENSEMBLE



Lavabo et colonne ULYSSE E899701
Porcelaine vitrifiée
50 x 44 cm
Lavabo P125401
Réf. IDE2090 - 6 395 F
Colonne P204201
Réf. IDE2093 - 4 995 F

NF

PORCHER
La confiance installée

11 390 F l'ensemble



Lavabo et colonne KHEOPS U220501
Porcelaine vitrifiée
60 x 48 cm
Lavabo T058401
Réf. IDE2074 - 14 695 F
Colonne T422401
Réf. IDE2072 - 9 995 F

NF

iSideal
STANDARD

24 690 F l'ensemble



Lavabo et colonne CONNECT E713601
Porcelaine vitrifiée
60 x 46 cm
Lavabo E714101
Réf. IDE2003 - 15 995 F
Colonne E711201
Réf. IDE2006 - 10 395 F

NF

iSideal
STANDARD

26 390 F l'ensemble

COLLECTIF



Lavabo collectif S327501
Céramique, 100 x 40 cm
Réf. IDE2102

NF

PORCHER
La confiance installée

24 395 F



Lavabo collectif P310001
Céramique, 95 x 33 cm
Réf. IDE2101

NF

PORCHER
La confiance installée

29 195 F



UNE EXPERTISE EN ROBINETTERIE



Fabricants de robinetterie depuis 1910 IDEAL STANDARD et PORCHER excellent dans la production de robinetterie de haute qualité, innovante et durable. Nous vous proposons une large palette de produits pour la salle de bains et la cuisine.

LAVE-MAIN

NF



PORCHER
La confiance installée

**Robinet lave-main
ULYSSE D1624AA**
Réf. IDE5207

4 595 F

ideal
STANDARD



**Robinet lave-main
KHEOPS B0759AA**
Réf. IDE5203

9 795 F

ROBINET

LAVABO



NF

ideal
STANDARD



**Mitigeur lavabo
OLYOS D1112AA**
+ tirette et vidage inclus
Réf. IDE5130

8 795 F



ideal
STANDARD



**Mitigeur lavabo
CONNECT BLUE B177AA**
Réf. IDE5090

11 195 F

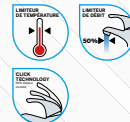

ideal
STANDARD



**Mitigeur lavabo
SLIME LINE II B0362AA**
+ tirette et vidage inclus
Réf. IDE5120

12 990 F



ideal
STANDARD



**Mitigeur lavabo
KEOPS B0753AA**
+ tirette
Réf. IDE5111

18 995 F



ideal
STANDARD



**Mitigeur lavabo
MARA A9010AA**
+ tirette
Réf. IDE5071

32 995 F



ideal
STANDARD



**Mitigeur lavabo
TONIC II A6328AA**
+ tirette
Réf. IDE5031

39 490 F

MITIGEUR



VASQUE À ENCASTRER

CARRÉ



Vasque HY - 5050
44 x 44 x 15 cm
Réf. SOMS278

9 495 F



Vasque HY - 6040
41,5 x 42 x 17 cm
Réf. SOMS279

9 495 F



Modèle STRADA - Réf. IDE2202

RECTANGLE



Vasque HY - 5075
60 x 40,5 x 15 cm
Réf. SOMS276

11 295 F



Vasque STRADA K0780
59 x 43 x 17 cm
Réf. IDE2202

26 395 F



624 Silicone Sanitaire translucide 300 ml PAREXLANKO
Réf. LAN3153

1 995 F



ROND/OVALE



Vasque HY - 5009
Ø40 x 11,5 cm
Réf. SOMS277

8 995 F



Vasque ULYSSE P1448
56 x 46 x 20 cm
Réf. IDE2241

8 295 F



Vasque CONNECT A7978
55 x 47,5 x 17,5 cm
Réf. IDE2203

21 395 F



VASQUE À POSER



Vasque HY - 405
37,5 x 37,5 x 14 cm
Réf. SOMS265

7 995 F



Vasque HY - 435
40 x 40 x 12 cm
Réf. SOMS268

7 995 F



Vasque HY - 8025
38,5 x 38,5 x 13,5 cm
Réf. SOMS267

8 995 F



Vasque HY - 5308
40 x 40 x 9 cm
Réf. SOMS271

9 495 F



Vasque HY - 4010
35 x 35 x 10,5 cm
Réf. SOMS266

9 995 F



Vasque HY - 8005
44,5 x 44,5 x 12 cm
Réf. SOMS270

9 995 F



Vasque HY - 8009
45,5 x 45,5 x 14,5 cm
Réf. SOMS269

11 295 F



Bonde quick/clak
Chromé WIRQUIN
Réf. WIR0032

1 995 F

CARRÉ



VASQUE À POSER

RECTANGLE

POP-UP



POP-UP CARRÉ
BLC BRILLANT
AVEC TROP PLEIN
Réf. SOMS324

2 895 F



POP-UP ROND
BLC BRILLANT
AVEC TROP PLEIN
Réf. SOMS322

2 895 F



**POP-UP /
VASQUES**
SANS TROP PLEIN
Réf. SOMS246

1 995 F



POP-UP ROND
CHR
AVEC TROP PLEIN
Réf. SOMS370

1 595 F



Vasque HY - 8024
38,5 x 50 x 13 cm
Réf. SOMS263

9 495 F



Vasque HY - 5039
48,5 x 60 x 16 cm
Réf. SOMS273

9 995 F



Vasque STRADA K0776
50 x 42 x 11,5 cm
Réf. IDE2201

27 795 F



Vasque COONECT AUR E0348
40 x 60 x 13cm
Réf. IDE2205

31 995 F



RONDE



Vasque HY - 3005
Ø40,5 x 13 cm
Réf. SOMS256

7 995 F



Vasque HY - 8008
Ø38,5 x 10,5 cm
Réf. SOMS255

8 995 F



Vasque HY - 8004
Ø44 x 12 cm
Réf. SOMS274

9 295 F



Vasque HY - 8011
Ø45 x 15 cm
Réf. SOMS275

9 495 F



Vasque CONNECT SPHÈRE
E8040
Ø43 x 13 cm
Réf. IDE2204

19 995 F



Vasque HY - 7026
Ø47 x 16 cm
Réf. SOMS906

11 990 F



SÉLECTION
SOMAC
MATÉRIAUX DE CONSTRUCTION



Vasque 7007
33 x 40,5 x 14 cm
Réf. SOMS904

6 995 F



Vasque HY - 5006
42 x 59 x 14 cm
Réf. SOMS257

8 995 F

OVALE



Vasque HY - 434
35 X 51 X 9,5 cm
Réf. SOMS258

8 995 F



Vasque HY - 5056
41,5 x 60 x 11,5 cm
Réf. SOMS260

9 495 F



Vasque HY - 8036
38 x 50,5 x 12 cm
Réf. SOMS272

9 495 F



Vasque HY - 8023
38,5 x 65 x 16 cm
Réf. SOMS259

9 995 F



Vasque HY - 5070
39,5 x 70 x 17 cm
Réf. SOMS261

13 495 F



Vasque HY - 5057
42,5 x 80 x 11,5 cm
Réf. SOMS262

13 995 F



RECEVEUR DE DOUCHE À POSER

RECEVEUR D'ANGLE



Receveur ULTRA FLAT
Acrylique
90 x 90 cm - K517601 - Réf. IDE4020
100 x 100 cm - K517701 - Réf. IDE4021 - 36 995 F

à partir de 33 595 F



Receveur CONNECT
Grès fin
90 x 90 cm - T266901
Réf. IDE4030

41 295 F



RECEVEUR CARRÉ



Receveur ULTRA FLAT
Acrylique
90 x 90 cm - K517301 - Réf. IDE4011
100 x 100 cm - K517401 - Réf. IDE4012 - 43 195 F

à partir de 34 995 F



Receveur ULYSSE
Acrylique
80 x 80 cm - P329401 - Réf. IDE4042
90 x 90 cm - P329301 - Réf. IDE4043 - 29 995 F

à partir de 16 995 F



**Bonde douche TWISTO
WIRQUIN**
Ø90 mm
Réf. WIR0004

2 995 F

RECEUR RECTANGLE



Receveur ULTRA FLAT
Acrylique
80 x 120 cm - K518201 - Réf. IDE4002
80 x 140 cm - K518501 - Réf. IDE4003 - 47 695 F
80 x 160 cm - K518701 - Réf. IDE4004 - 49 995 F

à partir de 41 295 F



**Bonde douche JAMES
WIRQUIN**
Orientable, Ø90 mm
Réf. WIR0005

3 195 F

CABINE DE DOUCHE



CARRÉ - PORTE COULISSANTE



ARRONDIE - PORTE COULISSANTE



RECTANGLE - PORTE COULISSANTE

Dimension			Réf.	PRIX
Larg.	Long.	Haut.		
90	90	200	SOMS570	49 995 F
100	100	200	SOMS571	54 990 F

Dimension			Réf.	PRIX
Larg.	Long.	Haut.		
90	90	200	SOMS573	49 995 F
100	100	200	SOMS574	53 990 F

Dimension			Réf.	PRIX
Larg.	Long.	Haut.		
180	80	200	SOMS572	66 995 F

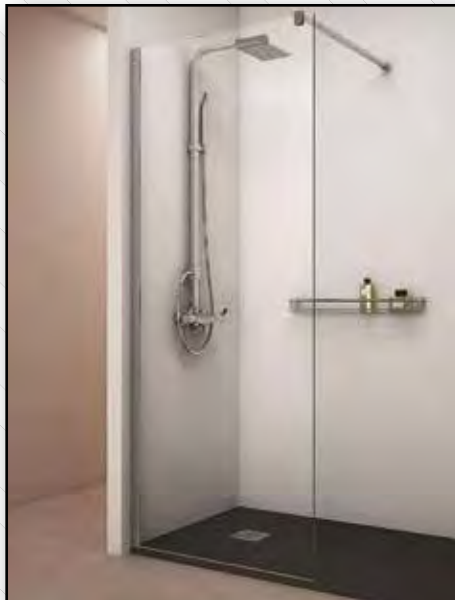

PAROI FIXE

Dimension			Réf.	PRIX
Larg.	Ép.	Haut.		
80	0,8	200	SOMS591	31 995 F
90	0,8	200	SOMS592	34 995 F
100	0,8	200	SOMS593	38 995 F
110	0,8	200	SOMS594	42 990 F
120	0,8	200	SOMS595	46 995 F



**Kit d'étanchéité
PAREXLANKO
Réf. LAN3116**

13 995 F

ACCESSOIRE



Rideaux de douche FLEUR
180 x 180 cm
Réf. SOMS511

995 F



**Rideaux de douche
MOSAÏQUE**
180 x 180 cm
Réf. SOMS517

995 F



**Rideaux de douche
GOUTTE**
180 x 180 cm
Réf. SOMS528

995 F

CABINE DE DOUCHE

PAROI DE DOUCHE

DÉCORATION



WEDI

PANNEAUX



PRÊT À CARRELER

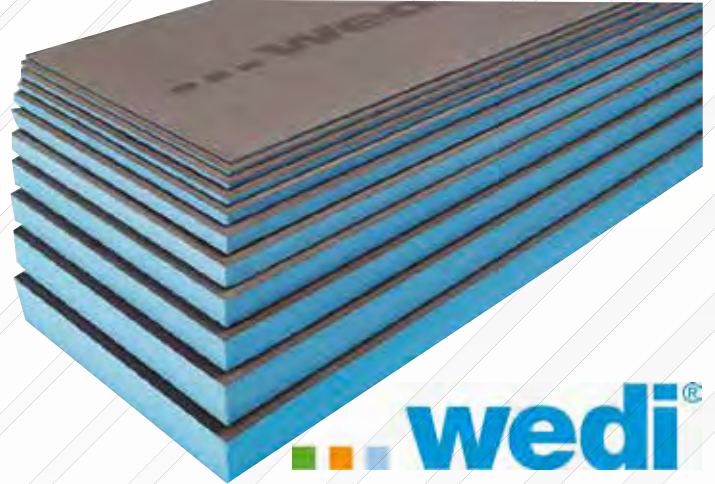

PANNEAU PRÊT À POSER

Dimension			Réf.	PRIX
Épaisseur	Largeur	Hauteur		
4 mm	125 cm	60 cm	WED0010	2 695 F
6 mm			WED0015	2 495 F
12,5 mm	250 cm	62,5 cm	WED0025	6 295 F
20 mm	250 cm	60 cm	WED0030	7 295 F
30 mm			WED0035	7 495 F
50 mm			WED0040	7 995 F

ACCESSOIRE

Cheville métallique
 Ø 50 mm
 Réf. WED0135
 Ø 80 mm
 Réf. WED0136 - 115 F

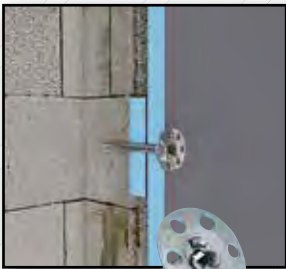

À partir de 95 F

Bande d'étanchéité
 12 cm x 10 m
 Réf. WED0115

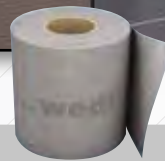
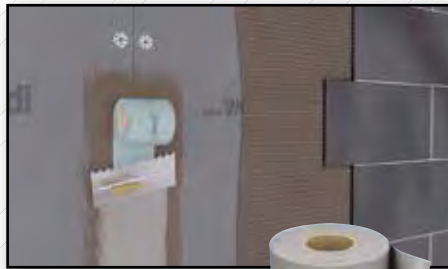

7 995 F

Connecteur panneaux 180°
 Réf. WED0152

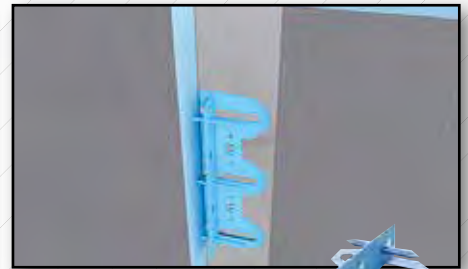

995 F

Connecteur panneaux 90°
 Réf. WED0151

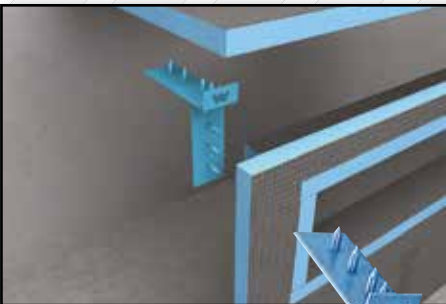

995 F

Connecteur panneaux mural
 Réf. WED0150

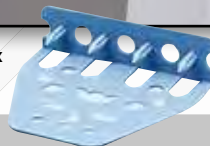

795 F

Weber colflex WEBER
 Gris
 Intérieur/Extérieur
 Sac de 25 kg
 Réf. WEB0201



4 995 F



RECEVEUR PRÊT À CARRELER ET À POSER

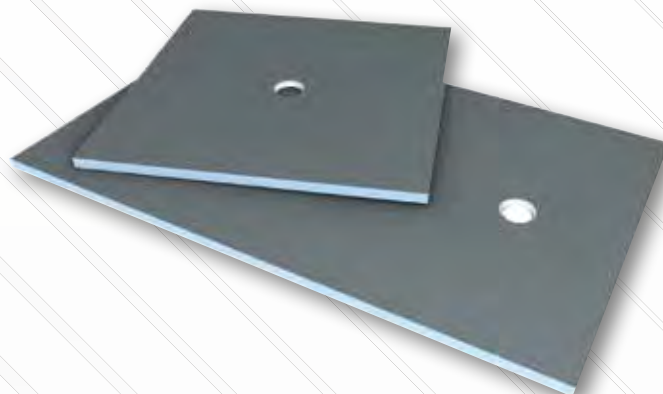

RECEVEUR PRÊT À CARRELER - ÉP. 40 MM

Dimension	Réf.	PRIX
90 x 90 cm	WED0210	41 990 F
90 x 120 cm	WED0220	49 595 F
90 x 180 cm	WED0230	61 995 F

L'UTILISATION D'UNE COLLE À CARRELER C2SET OBLIGATOIRE



RECEVEUR PRÊT À POSER - ÉP. 6 MM - EN CORIAN

Dimension	Réf.	PRIX
90 x 90 cm	WED0240	45 995 F
90 x 120 cm	WED0250	49 795 F
90 x 180 cm	WED0260	56 990 F

ACCESSOIRE



Kit d'étanchéité
WEDI
Réf. WED0120

12 990 F



Bande d'armature
autocollante
12,5 cm x 25 m
Réf. WED0110

3 290 F



Siphon de sol
WEDI
Ø 50 mm
Vertical - Réf. WED0310
Horizontal - Réf. WED0320

9 995 F



Colle polymère
WEDI
310 mL
Réf. WED0105

3 290 F

RECEVEUR



BAIGNOIRE

BAIGNOIRE D'ANGLE



Baignoire ULYSSE
Acrylique
135 x 135 cm - P107101
Réf. IDE4250

190 L

41 990 F



Baignoire KHEOPS
Acrylique
140 x 140 cm - J480801
Réf. IDE4220

245 L

59 995 F



BAIGNOIRE RECTANGLE

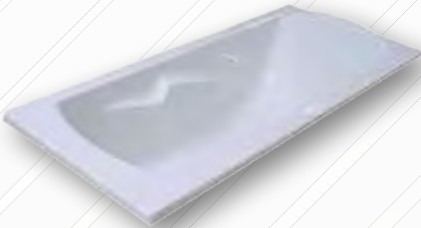

PORCHER
La confiance installée

Baignoire ULYSSE
Acrylique
170 x 70 cm - P104101
Réf. IDE4243

160 L

22 995 F



Baignoire KHEOPS
Acrylique
140 x 70 cm - J480201
Réf. IDE4222

260 L

38 995 F



Baignoire DUO
Acrylique
180 x 80 cm - K180801
Réf. IDE4241

265 L

37 995 F

ROBINETTERIE ET ACCESSOIRES



Mitigeur bain douche
OLYOS
D1145AA
Réf. IDE5616

PORCHER
La confiance installée

15 995 F



Mitigeur bain douche
SLIMLIME
D8587AA
Réf. IDE5614



17 995 F

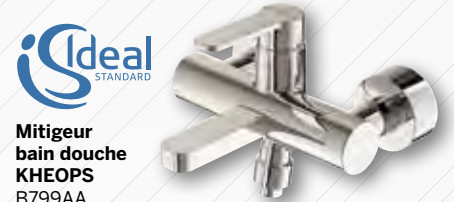

Mitigeur
bain douche
KHEOPS
B799AA
Réf. IDE5611

22 995 F



Mitigeur bain douche
CONNECT BLUE
B9921AA
Réf. IDE5625

23 990 F

BRIQUE DE VERRE



INCOLORÉ

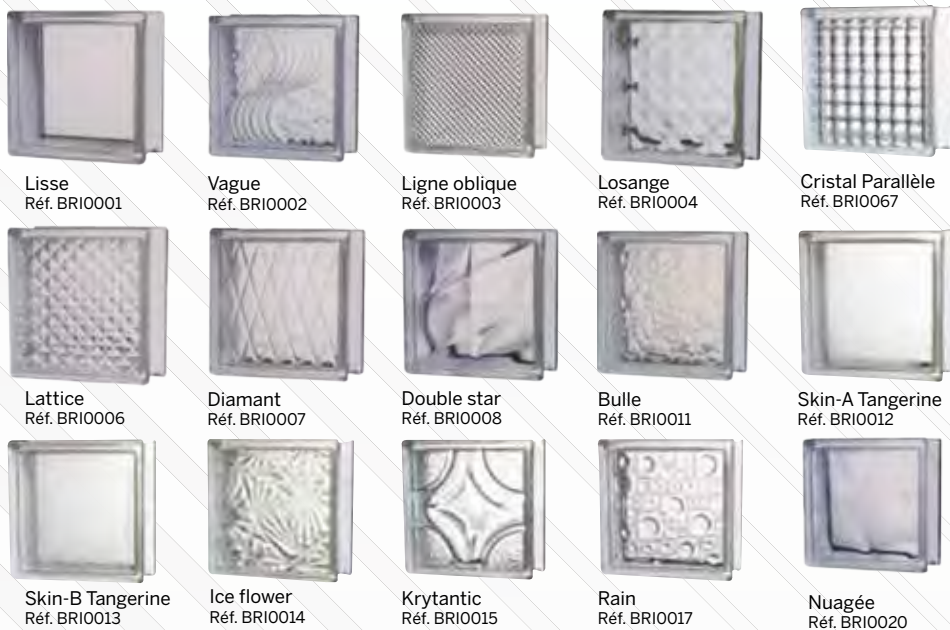

Lisse
Réf. BRI0001

Vague
Réf. BRI0002

Ligne oblique
Réf. BRI0003

Losange
Réf. BRI0004

Cristal Parallèle
Réf. BRI0067



Lattice
Réf. BRI0006



Diamant
Réf. BRI0007



Double star
Réf. BRI0008



Bulle
Réf. BRI0011

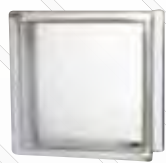

Skin-A Tangerine
Réf. BRI0012

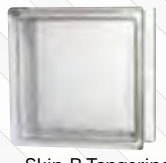

Skin-B Tangerine
Réf. BRI0013



Ice flower
Réf. BRI0014

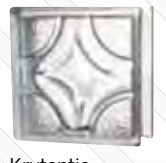

Krytantic
Réf. BRI0015



Rain
Réf. BRI0017



Nuagée
Réf. BRI0020

SPÉCIALE



Coin B - nuagée
Réf. BRI0023

Demi nuagée
Réf. BRI0021

Coin A - nuagée
Réf. BRI0022

Finition nuagée
Réf. BRI0024

Angle H nuagée
Réf. BRI0025

440 F

LISSE

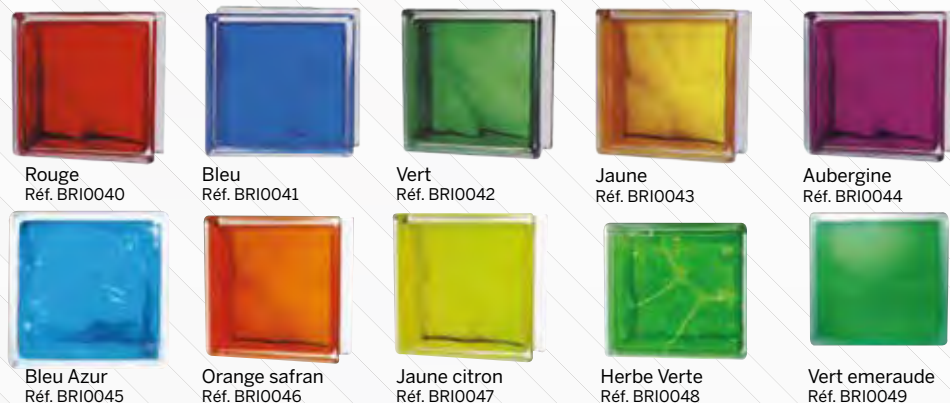

Rouge
Réf. BRI0040

Bleu
Réf. BRI0041

Vert
Réf. BRI0042

Jaune
Réf. BRI0043

Aubergine
Réf. BRI0044

Bleu Azur
Réf. BRI0045

Orange safran
Réf. BRI0046

Jaune citron
Réf. BRI0047

Herbe Verte
Réf. BRI0048

Vert emeraude
Réf. BRI0049

1 295 F

STRIÉE



Bleu
Réf. BRI0062

Saphir
Réf. BRI0063

Marron
Réf. BRI0066

Turquoise
Réf. BRI0064

Vert
Réf. BRI0065

695 F

NUAGÉE

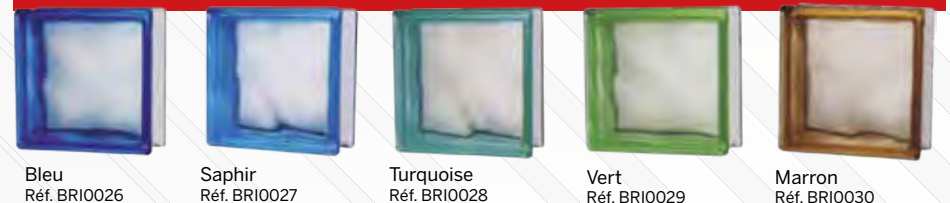

Bleu
Réf. BRI0026

Saphir
Réf. BRI0027

Turquoise
Réf. BRI0028

Vert
Réf. BRI0029

Marron
Réf. BRI0030

995 F

1 995 F

Dimensions : 19 x 19 x 8 cm

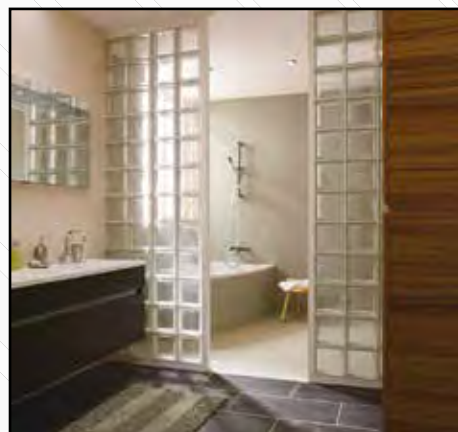

COLOREE



Cale plastique
80 x 10 mm
Réf. BRI0101

145 F



Imposte PVC
40,6 x 20,3 x 7,6 cm
Réf. BRI0120

4 995 F



DOUCHE

ENSEMBLE DE DOUCHE - SANS ROBINETTERIE

POMME RONDE



Ensemble de douche
TIARE - OT8609
Réf. SOMS858

18 995 F



Ensemble de douche
TETUANUI - OT8629
Réf. SOMS860

18 995 F



Ensemble de douche
HAUARII - OT8610
Réf. SOMS804

25 990 F



Ensemble de douche
MARAMA - OT8606
Réf. SOMS803

27 995 F

CHAUFFE-EAU



GAZ - ALLUMAGE ÉLECTRONIQUE - INTÉRIEUR

Capacité	Réf.	PRIX
6 L	SOMS701	9 995 F
10 L	SOMS702	15 995 F



GAZ - ALLUMAGE ÉLECTRONIQUE
INTÉRIEUR - EXTÉRIEUR

Capacité	Réf.	PRIX
6 L	SOMS705	17 995 F
10 L	SOMS704	19 995 F

ACCESSOIRES



Grille
d'aération
Avec monstiquaire
Ø 120 mm, Blanc
Intérieur/extérieur
Réf. HBH0120

825 F



Gaine
semi-rigide
Ø 112 mm
Longueur 1,50m
Réf. HBH0023

1 495 F



Gaine d'aération
Spéciale chauffe-eau
Ø 97 mm, aluminium
Réf. HBH0151

5 290 F

PLOMBERIE



MÉLANGEUR



Mélangeur bain douche
ULYSSE
D1643AA
Réf. IDE5620

12 490 F

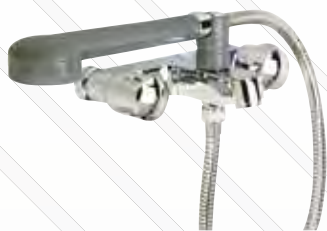

Mélangeur bain douche
ULYSSE
D1743AA
Réf. IDE5619

18 995 F

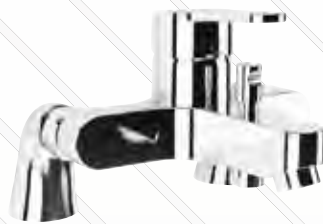

Mélangeur bain douche
AMBRE
D2048AA
Réf. IDE5621

19 395 F



Mélangeur bain douche
KÉOPS
D2242AA
Réf. IDE5618

21 995 F

MITIGEUR



Mitigeur bain douche
OLYOS
D1145AA
Réf. IDE5616

PORCHER
La confiance installée.

15 995 F



Mitigeur bain douche
KÉOPS
B0755AA
Réf. IDE5613

17 995 F



Mitigeur bain douche
SLIMLIME
D8587AA
Réf. IDE5614

17 995 F



Mitigeur bain douche
KHEOPS
B799AA
Réf. IDE5611

22 995 F



BAIN-DOUCHE



Mitigeur bain douche
CONNECT BLUE
B0179AA
Réf. IDE5610

22 995 F

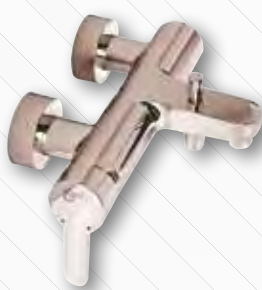

Mitigeur bain douche
CONNECT BLUE
B9921AA
Réf. IDE5625

23 990 F



Mitigeur bain douche
OLYOS
D1142AA
Réf. IDE5615

23 995 F



Mitigeur bain douche
CERAMSPRINT
B0089AA
Réf. IDE5609

25 990 F



Mitigeur bain douche
MARA
A9013AA
Réf. IDE5608

26 990 F



Mitigeur bain douche
TONIC II
A6338AA
Réf. IDE5604

43 995 F



Mitigeur bain douche
THERMOSTATIC MELANGE
A4281AA
Réf. IDE5601

48 995 F



Mitigeur bain douche
NEON
A6408AA
Réf. IDE5603

49 995 F



HYDROTHÉRAPIE

POMME RONDE



Ensemble de douche
MIHITUA - OT8643
Réf. SOMS899

22 995 F



Ensemble de douche
HEIMANU - OT8641
Réf. SOMS892

24 995 F

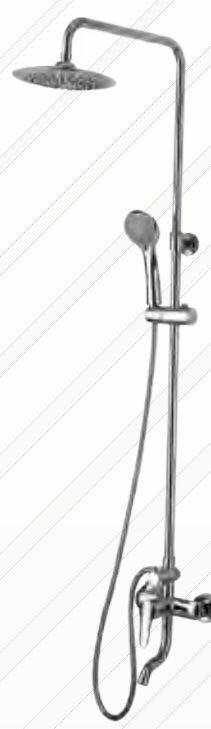

Ensemble de douche
PITATE - OT8632
Réf. SOMS883

25 990 F



Ensemble de douche
HEREHIA - OT8651
Réf. SOMS874

25 990 F

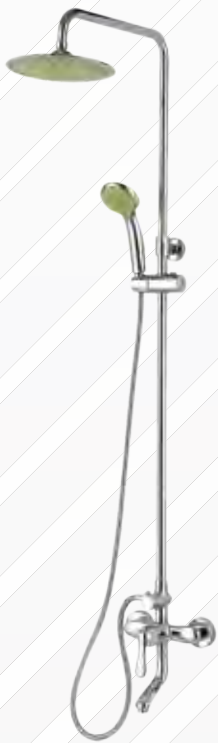

Ensemble de douche
POEITI - OT8636
Réf. SOMS882

29 995 F



Ensemble de douche
AVEARII - OT8602
Réf. SOMS898

38 995 F



Ensemble de douche
MIHINUI - OT8645
Réf. SOMS875

41 995 F



Ensemble de douche
TEHERE - OT8648
Réf. SOMS896

42 995 F

ENSEMBLE DE DOUCHE - AVEC ROBINETTERIE

HYDROTHÉRAPIE



ROBINETTERIE BAIN DOUCHE



Ensemble de douche
VAIMITI - OT8654
Réf. SOMS897

46 995 F



Ensemble de douche
HEIANI - OT8642
Réf. SOMS893

49 995 F



Ensemble de douche
HERENUI - OT8647
Réf. SOMS895

49 995 F



Ensemble de douche
HEREITI - OT8644
Réf. SOMS894

59 995 F

MIROIR

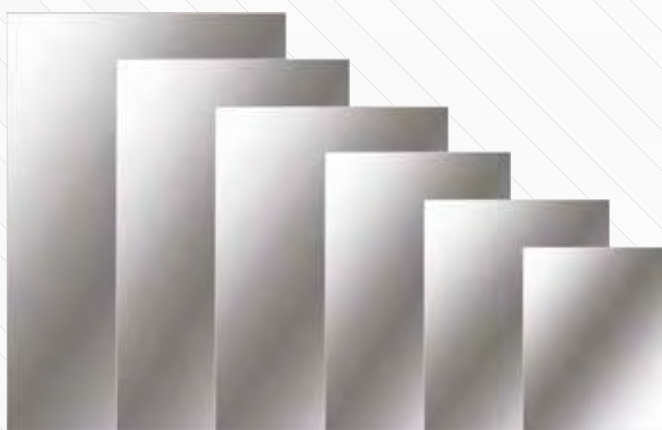

MIROIRS BORDS POLIS

Capacité	Réf.	PRIX
40 x 30	MIR0021	1 495 F
50 x 40	MIR0022	2 495 F
60 x 40	MIR0023	2 995 F
70 x 50	MIR0025	4 290 F
80 x 50	MIR0026	4 995 F
90 x 60	MIR0027	6 995 F

à partir de 1 495 F



Fixation miroir
Ronde chromée
Réf. MIR0081

1 295 F



Fixation
miroir
en «U» blanche
Réf. MIR0085

1 495 F



Fixation miroir
Cadre blanche
Réf. MIR0088

1 595 F



Fixation miroir
Carré arrondi chromée
Réf. MIR0094

1 695 F

ENSEMBLE DE DOUCHE - AVEC ROBINETTERIE



HYDROTHÉRAPIE

POMME CARRÉ - AVEC ROBINETTERIE



Ensemble de douche
RAIMANA - OT8640
Réf. SOMS839

23 995 F



Ensemble de douche
HEIMATA - OT8638
Réf. SOMS840

29 995 F

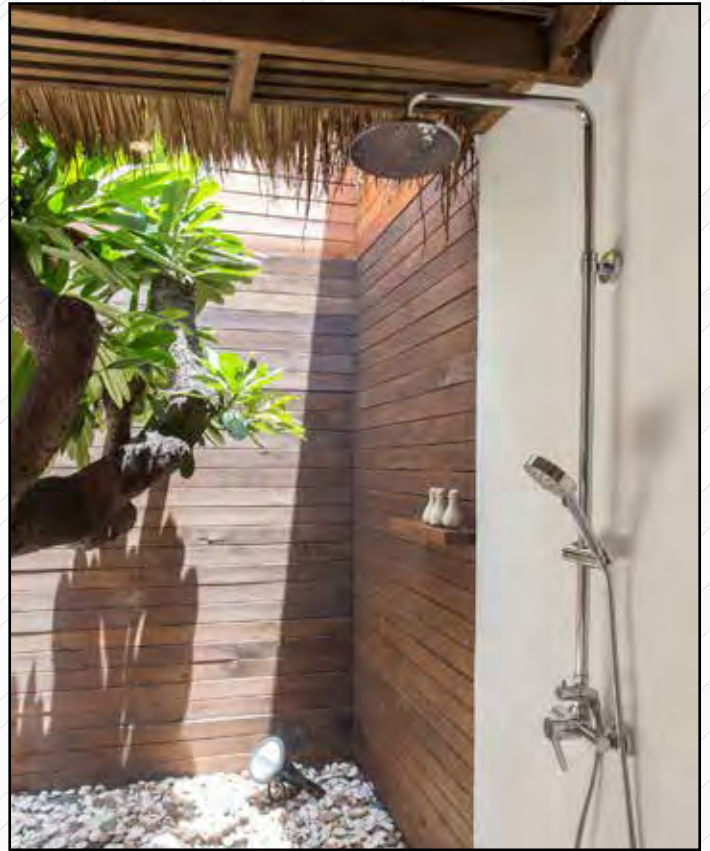

ENSEMBLE DE DOUCHE - AVEC ROBINETTERIE



Ensemble de douche
WEENA - OT8611
Réf. SOMS834

29 995 F



Ensemble de douche
TERE - OT8623
Réf. SOMS833

32 995 F



Ensemble de douche
HOATINI - OT8652
Réf. SOMS837

34 995 F



Ensemble de douche
MANUA - OT8646
Réf. SOMS835

39 990 F

HYDROTHÉRAPIE



POMME CARRÉ - AVEC ROBINETTERIE



Ensemble de douche
MANOA - OT8656
Réf. SOMS838

39 990 F



Ensemble de douche
ARIII - OT8653
Réf. SOMS841

42 995 F



Ensemble de douche
VARUA - OT8649
Réf. SOMS836

43 995 F



Ensemble de douche
MARUTEA - OT8621
Réf. SOMS832

45 995 F

ARMOIRE DE TOILETTE



Armoire
1 porte
TEMPO
60 x 40 x 17
Réf. MIRO174

13 595 F



Armoire 2 portes
TEMPO
60 x 460 x 17
Réf. MIRO175

14 995 F

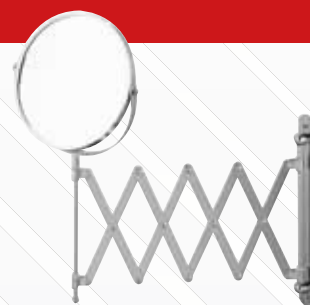

Miroir grossissant x 2
Extensible
Ø 15 - chromé
Réf. MIRO061

2 995 F



Armoire
à pharmacie
GENOA
50 x 30 x 15
Réf. MIRO172

6 595 F



Armoire petites urgences
45 x 30 x 15
Réf. MIRO181

9 995 F

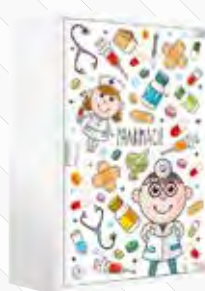

Armoire à pharmacie
45 x 30 x 15
Réf. MIRO182

9 995 F



Miroir
grossissant x 8
Rond pivotant
Ø 20 - chromé
Réf. MIRO067

7 995 F

ENSEMBLE DE DOUCHE - AVEC ROBINETTERIE



ACCESSOIRE SALLE DE BAIN

BLANC OU METALLISÉ

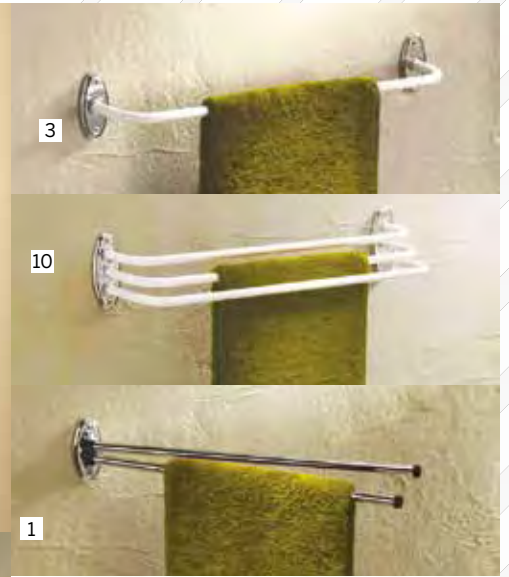

1 • 0402C1 - Réf. GOD0107 - **2 495 F**
5 • 0492B1 - Réf. GOD0129 - **2 995 F**
9 • 072611 - Réf. GOD0110 - **2 695 F**

2 • 0403C1 - Réf. GOD0108 - **2 395 F**
6 • 072401 - Réf. GOD0122 - **1 190 F**
10 • 04511 - Réf. GOD0106 - **5 190 F**

3 • 042151S1 - Réf. GOD0104 - **2 495 F**
7 • 0725011 - Réf. GOD0121 - **1 295 F**
11 • 0712R1 - Réf. GOD0133 - **2 595 F**

4 • 0422C1 - Réf. GOD0102 - **3 195 F**
8 • 071801 - Réf. GOD0115 - **2 015 F**
12 • 071221 - Réf. GOD0134 - **3 195 F**

à partir de **1 190 F**

AMÉNAGEMENT DOUCHE

AMÉNAGEMENT DOUCHE



Barre droite
60 cm
Réf. GOD0202

5 190 F



Barre mono
Taupe,
Réf. GOD0217

4 790 F



Planche de bain
8 lattes
Réf. GOD0224

15 690 F



Barre droite
30 cm
Réf. GOD0222

2 495 F



Barre coude
Taupe,
Réf. GOD0208

9 395 F



Tabouret de bain
4 lattes
Réf. GOD0227

16 995 F

ACCESSOIRE SALLE DE BAIN



MIRROIR



Miroir PORTLAND
70 x 60 cm
Réf. MIR0156

27 995 F



Miroir PORTLAND
70 x 80 cm
Réf. MIR0157

29 995 F



Miroir PORTLAND
70 x 100 cm
Réf. MIR0159

34 995 F



**Armoire LED
GIULIA**
60 x 80 x 17 cm
Réf. MIR0180

44 995 F

AMÉNAGEMENT DOUCHE



Siège de bain
Réf. GOD0226

12 395 F

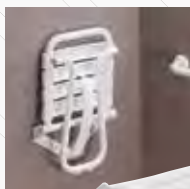

**Tabouret
de douche**
4 lattes
Réf. GOD0225

22 895 F



ÉCLAIRANT

AMÉNAGEMENT DOUCHE



ACCESSOIRE SALLE DE BAIN

SÉRIE CHROMÉE CUBIQUE 3600

GAMME CHROMÉE CUBIQUE



Étagère
Réf. SOMS444

6 995 F



Barre simple
Réf. SOMS443

4 790 F



Porte savon
Réf. SOMS446

2 595 F



Patère
Réf. SOMS445

1 595 F



Étagère / porte-serviettes
Réf. SOMS441

8 995 F



Barre double
Réf. SOMS442

6 495 F



Porte brosse à dents
Réf. SOMS447

2 595 F



Brosse WC
+ pot
Réf. SOMS448

4 995 F

GAMME POLISHED

SÉRIE POLISHED 82 700



Étagère
Réf. SOMS454

6 795 F



Barre simple
Réf. SOMS453

4 595 F



Porte savon
Réf. SOMS456

2 495 F



Patère
Réf. SOMS455

1 595 F



Étagère / porte-serviettes
Réf. SOMS451

9 995 F



Barre double
Réf. SOMS452

5 790 F



Porte brosse à dents
Réf. SOMS457

2 495 F



Brosse WC
+ pot
Réf. SOMS458

3 395 F

ACCESSOIRE SALLE DE BAIN



ÉTAGÈRE

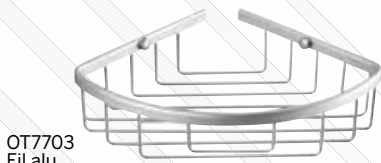

OT7703
Fil alu
Réf. SOMS405 - **1 295 F**



OT7715
Fil inox
Réf. SOMS407 - **2 595 F**

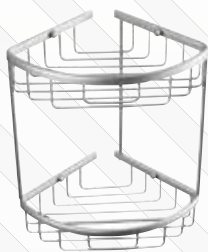

OT7704
Fil alu
Réf. SOMS406 - **2 495 F**

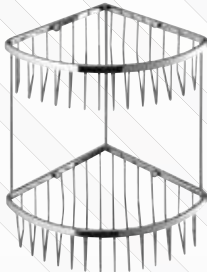

OT7716
Fil inox
Réf. SOMS408 - **4 795 F**

BARRE POUR SERVIETTE



OT7301
Réf. SOMS409 - **1 695 F**

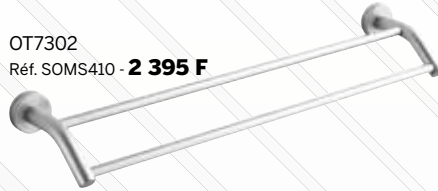

OT7302
Réf. SOMS410 - **2 395 F**

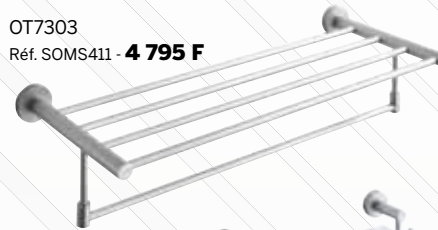

OT7303
Réf. SOMS411 - **4 795 F**



OT7304
Réf. SOMS412
5 495 F

ACCESSOIRES

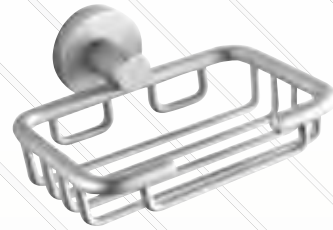

OT7308
Réf. SOMS415
1 295 F



Anneau serviette
OT7309
Réf. SOMS416
1 195 F

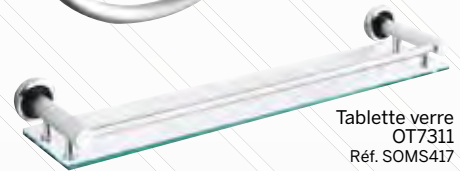

Tablette verre
OT7311
Réf. SOMS417
3 395 F

à partir de **1 295 F**

à partir de **1 695 F**

à partir de **1 195 F**

GAMME BLACK



Étagère
Réf. SOMS464

8 495 F



Barre simple
Réf. SOMS463

5 395 F



Porte savon
Réf. SOMS466

2 790 F



Patère
Réf. SOMS465

1 790 F

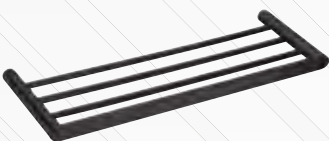

Étagère / porte-serviettes
Réf. SOMS461

12 195 F

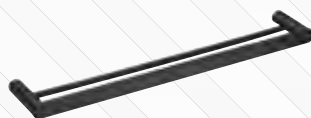

Barre double
Réf. SOMS462

6 995 F



Porte brosse à dents
Réf. SOMS467

2 790 F



Brosse WC + pot
Réf. SOMS468

3 995 F

SÉRIE ALU BROSSÉ

SÉRIE BLACK RONDE



CARRELAGE

GAMME MAGNETIC

CARRELAGE
30 x 30 cm
Épaisseur : 8 mm
2 195 F / m²
 Soit 3 007 F le paquet de 1,37 m²



Habitation



Extérieur



Passage
léger



Sol



V2



Gel



Réf. : DES0101

Réf. : DES0103

Réf. : DES0105

Réf. : DES0107



Réf. : DES0103



Réf. : DES0105

GRIS CERAME ÉMAILLÉ

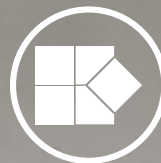

GAMME LOUISIANE

CARRELAGE

à partir de

2 695 F / m²

Soit 3 692F le paquet de 1,37 m²



Habitation



Extérieur



Anti-dérapant



Sol



Gel



Passage intense



Réf. : BILOXI



Réf. : MONROE



Réf. : LAFAYETTE



Réf. : BILOXI

GRES CERAME EMAILLE

Dimension en cm	épais. en mm	Réf.	PRIX au m ²	PRIX (paquet)
30 x 30 Par paquet de 1,37m ² soit 15 carreaux	8	Monroe - DES0001	2 695 F	3 692 F
		Lafayette - DES0003		
		Biloxi - DES0005		
45 x 45 Par paquet de 1,014m ² soit 5 carreaux	9	Monroe - DES0011	2 895 F	2 936 F
		Lafayette - DES0013		
		Biloxi - DES0015		
60 x 60 Par paquet de 1,08m ² soit 3 carreaux	9,5	Monroe - DES0021	3 495 F	3 775 F
		Lafayette - DES0023		
		Biloxi - DES0025		



CARRELAGE

GAMME DIVA

CARRELAGE

à partir de

3 495 F / m²

Soit 3 775 F le paquet de 1,08 m²



Habitation



Extérieur



Sol



Passage intense



Anti-dérapant

Gel



Réf. : LICIA

GRIS CERAME ÉMAILLÉ



Réf. : LICIA



Réf. : MADO



Réf. : KIRSTEN

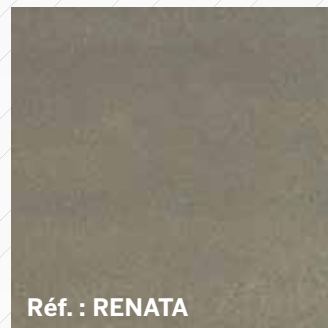

Réf. : RENATA

Dimension en cm	épais. en mm	Réf.	PRIX au m ²	PRIX (paquet)
30 x 60 Par paquet de 1,08m ² soit 6 carreaux	9,5	Licia - DES0051	3 495 F	3 775 F
		Mado - DES0053		
		Kirsten - DES0055		
		Renata - DES0057		
60 x 60 Par paquet de 1,08m ² soit 3 carreaux	9,5	Licia - DES0061	4 295 F	4 639 F
		Kirsten - DES0063		

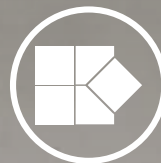

GAMME PORPHYRES



Carrelage PORPHYRES
GERARDMER
30 x 30 cm
Épaisseur : 8 mm

2 195 F / m²

Soit 3 007 F le paquet de 1,37m²
Réf. DES0151

GAMME UNI



Carrelage UNI
GENEVE
30 x 30 cm
Épaisseur : 8 mm

2 195 F / m²

Soit 3 007 F le paquet de 1,37m²
Réf. DES0161

GAMME MASH-UP



Carrelage MASH UP
BEIGE
45 x 45 cm
Épaisseur : 9 mm

2 485 F / m²

Soit 2 520 F le paquet de 1,014m²
Réf. DES0171

GAMME PONDYCHERY



Carrelage PONDYCHERY
BHARATHI
45 x 45 cm
Épaisseur : 9 mm

2 485 F / m²

Soit 2 520 F le paquet de 1,014m²
Réf. DES0181

GAMME ARMADA



Carrelage ARMADA
CLIPPER
60 x 60 cm
Épaisseur : 9,5 mm

2 995 F / m²

Soit 3 235 F le paquet de 1,08m²
Réf. DES0193

GAMME ARDESIE



Carrelage ARDESIE
ANTHRACITE
60 x 60 cm
Épaisseur : 9,5 mm

2 995 F / m²

Soit 3 235 F le paquet de 1,08m²
Réf. DES0205

GRES CERAME EMAILLÉ



CARRELAGE

GAMME LANZ

Carrelage LANZ
60 x 60 cm
Épaisseur : 9,6 mm

2 295 F / m²

Soit 3 305 F le paquet de 1,44m²



Réf. : SOMC053

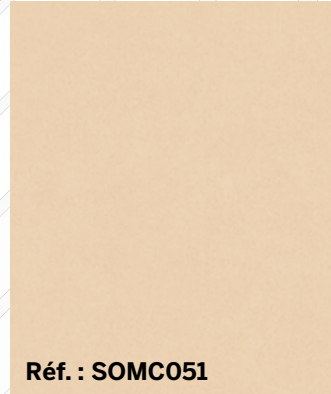

Réf. : SOMC051



Réf. : SOMC052



Réf. : SOMC053



Réf. : SOMC054

GAMME BURLINGTON



Réf. : SOMC031



Réf. : SOMC032



Réf. : SOMC033



Réf. : SOMC034



Carrelage BURLINGTON
60 x 60 cm
Épaisseur : 10 mm

3 290 F / m²

Soit 4 737 F le paquet de 1,44m²

Réf. : SOMC032

GRES CERAME

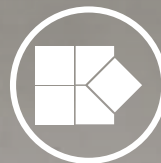

GAMME ALES



Gris clair



Gris anthracite



Dimension en cm	épais. en mm	Réf.	PRIX au m ²	PRIX (paquet)
60 x 60 Par paquet de 1,44m ² soit 4 carreaux	10	Gris clair - SOMC001	2 995 F	4 313 F
		Gris Anthracite - SOMC002		
90 x 45 Par paquet de 1,215m ² soit 3 carreaux	11	Gris clair - SOMC011	3 495 F	4 246 F
		Gris Anthracite - SOMC012		
120 x 60 Par paquet de 1,44m ² soit 2 carreaux	11,5	Gris clair - SOMC021	4 995 F	7 193 F
		Gris Anthracite - SOMC022		

GAMME BLANC



Dimension en cm	épais. en mm	Réf.	PRIX au m ²	PRIX (paquet)
60 x 60 Par paquet de 1,44m ² soit 4 carreaux	9,3	SOMC041	2 995 F	4 313 F
30 x 60 Par paquet de 1,44m ² soit 8 carreaux	9,3	SOMC042	3 290 F	4 737 F
80 x 80 Par paquet de 1,92m ² soit 3 carreaux	10,3	SOMC043	3 490 F	6 701 F



CARRELAGE

GAMME COLORÉE



Carrelage FAÏENCE
15 x 15 cm - Épaisseur : 6,5 mm

100 F / unité



Réf. : CAR0311

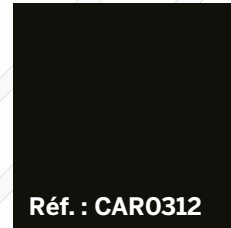

Réf. : CAR0312



Réf. : CAR0313



Réf. : CAR0314



Réf. : CAR0316



Réf. : CAR0318

GAMME BLANC

FAÏENCE



Dimension en cm	épais. en mm	Réf.	PRIX au m ²	PRIX (paquet)
15 x 15 Par paquet de 1m ² soit 44 carreaux	6	CAR0302	995 F	995 F
20 x 20 Par paquet de 1m ² soit 25 carreaux	6	CAR0303	1 690 F	1 690 F
30 x 60 Par paquet de 1,26m ² soit 7 carreaux	9,5	CAR0353	2 495 F	3 144 F

COLLES CARRELAGE

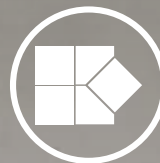

SIKALATEX 360
Résine
d'accrochage
2L - Réf. SIKA014 - 4 195 F
5L - Réf. SIKA015 - 7 995 F
20L - Réf. SIKA016 - 26 990 F

à partir de 4 195 F



48 m²
environ

**165 PROLIPIRM
UNIVERSEL
PAREX LANKO**
Primaire
d'accrochage
pour mortier
et colle
Réf. LAN4114



**+ 5 litres
+ 1 L OFFERT**

8 995 F



**COL'GRES
WEBER**
Gris, 25 kg
Réf. WEB0203

2 495 F



**COL'PLUS
WEBER**
Gris, 25 kg
Réf. WEB0204

3 495 F



COL'FLEX WEBER
Gris, 25 kg
Application
carrelage
sans primaire
Réf. WEB0201

4 995 F



**CERMICOL EXTRA
CERMIX**
Gris, 25 kg
Réf. CERMI03

1 995 F



**CERMIGRES
CERMIX**
Gris, 25 kg
Réf. CERMI10

2 290 F



**CERMIPLUS
CERMIX**
Gris, 25 kg
Réf. CERMI06

3 895 F

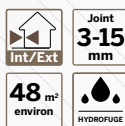

**CERMI JOINT TX
CERMIX**
Gris, 25 kg
Réf. CERMI20

3 495 F



PRB JOINT FIN
Gris, 20 kg
Réf. PRB0021

3 995 F



**JOINT FIN
WEBER**
Gris, 25 kg
Réf. WEB0302

3 995 F

ACCROCHAGE

COLLE CARREAUX

COLLE JOINT



REVÊTEMENT DE SOL

PVC

GAMME ÉCO



Réf. : IVC2704



Réf. : IVC2701

Largeur : 4 m
Épaisseur : 1,15 mm
Couche d'usure : 0,15 mm

995 F / m²
Soit 3 980 F le mètre

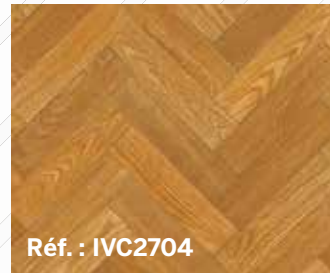

Réf. : IVC2704



Réf. : IVC2702

GAMME PRESTO

Largeur : 4 m
Épaisseur : 2,8 mm
Couche d'usure : 0,20 mm

1 290 F / m²
Soit 5 160 F le mètre

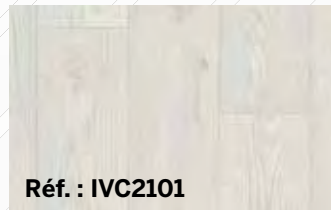

Réf. : IVC2101

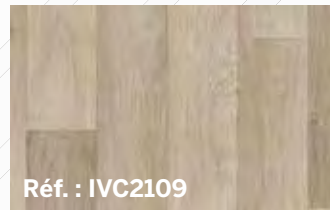

Réf. : IVC2109



Réf. : IVC2107

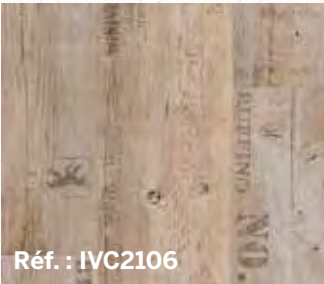

Réf. : IVC2106



Réf. : IVC2111



Réf. : IVC2103



Réf. : IVC2104

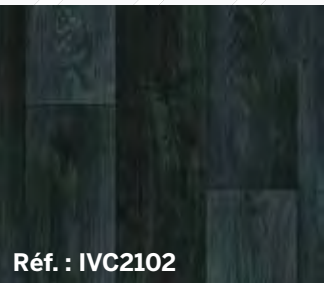

Réf. : IVC2102

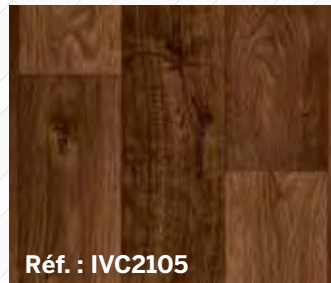

Réf. : IVC2105



Réf. : IVC2110



Réf. : IVC2113



Réf. : IVC2110

DÉCOR - PARQUET

GAMME BINGO



Réf. : IVC2212



Réf. : IVC2208

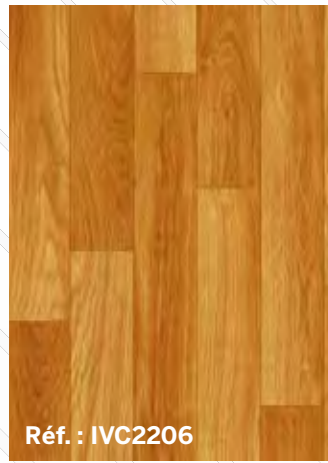

Réf. : IVC2206



Réf. : IVC2215

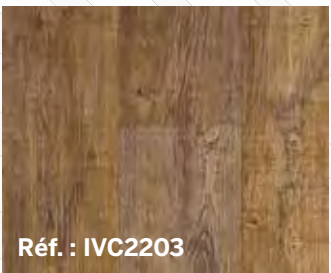

Réf. : IVC2203



Réf. : IVC2204



Réf. : IVC2213

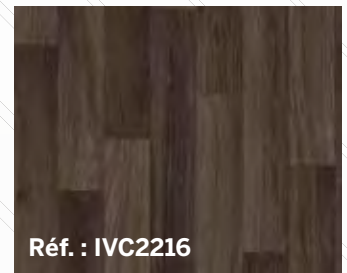

Réf. : IVC2216

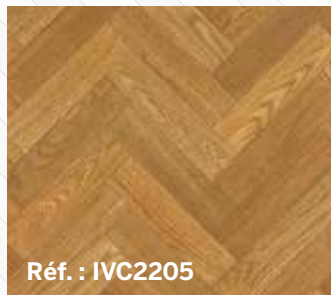

Réf. : IVC2205

Largeur : 4 m
 Epaisseur : 2,8 mm
 Couche d'usure :
 0,20 mm
1 290 F / m²
 Soit 5 160 F le mètre



Réf. : IVC2210

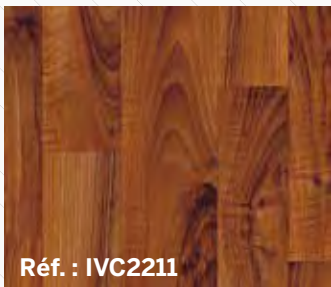

Réf. : IVC2211



Réf. : IVC2213

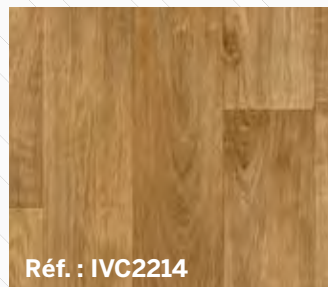

Réf. : IVC2214



Réf. : IVC2217

GAMME NOVA

Largeur : 4 m
 Epaisseur : 2,5 mm
 Couche d'usure : 0,25 mm

1 395 F / m²
 Soit 5 580 F le mètre



Réf. : IVC2301

GAMME ATLAS

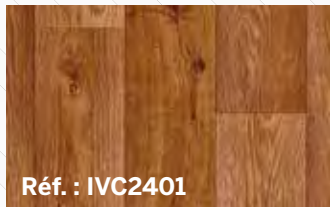

Réf. : IVC2401

Largeur : 4 m
 Epaisseur : 3,8 mm
 Couche d'usure : 0,20 mm

1 695 F / m²
 Soit 6 780 F le mètre

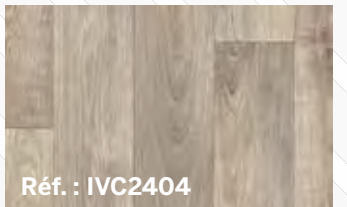

Réf. : IVC2404

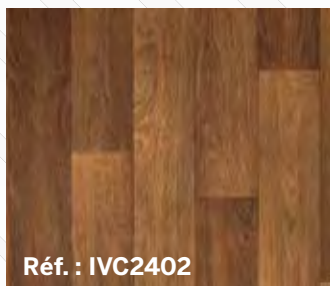

Réf. : IVC2402



Adhésif double face
 50 mm x 25 m
 Réf. PLA0060

1 795 F

DÉCOR CARRELAGE

DÉCOR DIVERS



REVÊTEMENT DE SOL

PVC

GAMME BINGO



Réf. : IVC3212

DÉCOR CARRELAGE

Largeur : 4 m
Épaisseur : 2,8 mm
Couche d'usure : 0,20 mm
1 290 F / m²
Soit 5 160 F le mètre



Réf. : IVC3213



Réf. : IVC3214



Réf. : IVC3209



Réf. : IVC3208



Réf. : IVC3210



Réf. : IVC3201

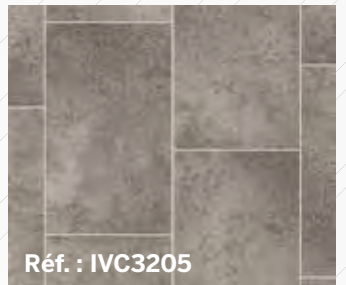

Réf. : IVC3205



Réf. : IVC3202

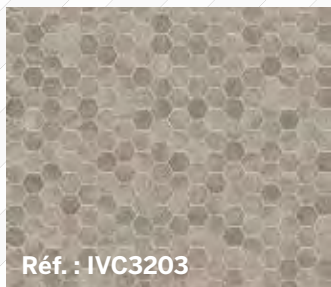

Réf. : IVC3203



Réf. : IVC3217



Réf. : IVC3215

GAMME BINGO



Réf. : IVC4203

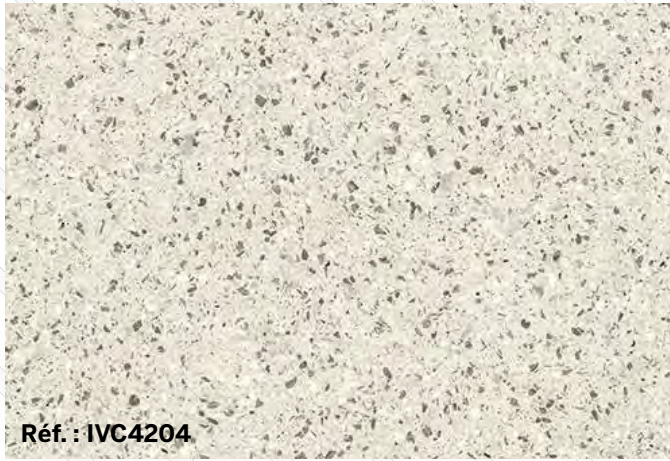

Réf. : IVC4204



Réf. : IVC4206



Réf. : IVC4205



Réf. : IVC4202

Largeur : 4 m
 Epaisseur : 2,8 mm
 Couche d'usure : 0,20 mm
1 290 F / m²
 Soit 5 160 F le mètre



Réf. : IVC4201

DÉCOR MOTIF

GAMME NOVA

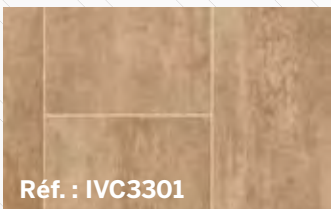

Réf. : IVC3301



Largeur : 4 m
 Epaisseur : 2,5 mm
 Couche d'usure : 0,25 mm
1 395 F / m²
 Soit 5 580 F le mètre

Réf. : IVC3303



Réf. : IVC3303



Réf. : IVC3302



Réf. : IVC3304



PARQUET STRATIFIÉ

PARQUET FLOTTANT



Réf. : SOMP516



Réf. : SOMP536



Réf. : SOMP501



Réf. : SOMP565

Vendu par paquet de 2,36 m².
Soit 10 lames de
1 210 x 195 x 8,3 mm.
1 495 F / m²
Soit 3 528 F le paquet

CLICK SYSTEM
Unilin click joint



Facile à installer

Pas besoin de colle



Réf. : SOMP571



Réf. : SOMP580



Sous-couche BASIC
Largeur : 1m
Épaisseur : 2 mm
Réf. SOMP904

140 F/m. linéaire

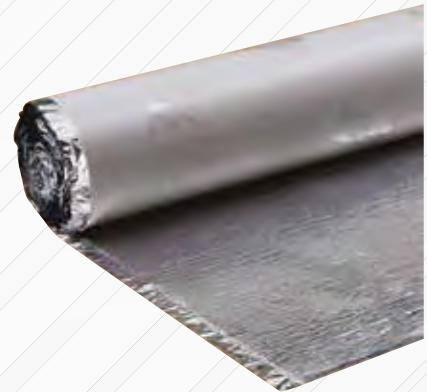

Sous-couche ALU
Largeur : 1m10
Épaisseur : 2 mm
Réf. SOMP903

195 F/m. linéaire

PARQUET VINYLE



Réf. : SOMP804



Réf. : SOMP805

Vendu par paquet de 1,53 m².
Soit 11 lames de
1 524 x 914 x 4 mm.

2 990 F / m²

Soit 4 575 F le paquet



Facile à
installer

Pas besoin
de colle



Réf. : SOMP803

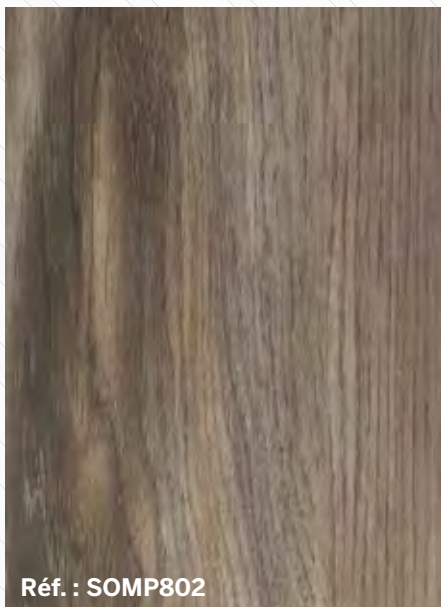

Réf. : SOMP802

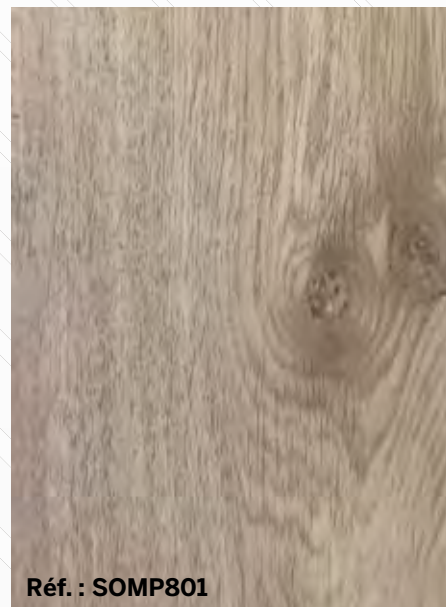

Réf. : SOMP801

PARQUET FLOTTANT



Réf. : SOMP806



Sous-couche SOMAT
Largeur : 1m10
Épaisseur : 3 mm
Réf. SOMP905

215 F/m. linéaire



Sous-couche VELAMOUSE
Largeur : 1m50
Épaisseur : 3 mm
Réf. SOMP906

350 F/m. linéaire



PARQUET MASSIF

INTÉRIEUR

RADIATA

4 895 F
le mètre carré

Vendu par lame de
140 x 18 x 3 600 mm.

2 467 F / lame

Réf. SOMP702

Vendu par lame de
140 x 18 x 3 720 mm.

2 550 F / lame

Réf. SOMP704

CERISIER

8 495 F
le mètre carré

Vendu par carton de 1,35m² soit
18 lames de 610 x 123 x 18 mm.

11 468 F / carton

Réf. SOMP608

CHÊNE

8 995 F
le mètre carré

Vendu par carton de 1,35m² soit
18 lames de 610 x 123 x 18 mm.

12 143 F / carton

Réf. SOMP609

IROKO

8 995 F
le mètre carré

Vendu par carton de 1,35m² soit
18 lames de 610 x 123 x 18 mm.

12 143 F / carton

Réf. SOMP610

MERBAU

9 495 F
le mètre carré

Vendu par carton de 1,998m² soit
18 lames de 910 x 122 x 18 mm.

18 971 F / carton

Réf. SOMP607

TECK AFRICAIN

9 990 F
le mètre carré

Vendu par carton de 1,998m² soit
18 lames de 910 x 122 x 18 mm.

19 960 F / carton

Réf. SOMP611



MOQUETTE PODIUM

Largeur : 2 m
Épaisseur : 3 mm

985 F / m²

Soit 1 970 F le mètre



Réf. : BEA0001



Réf. : BEA0001



Réf. : BEA0002



Réf. : BEA0003



Réf. : BEA0004

MOQUETTE PASSAGE



Réf. : BEA0210

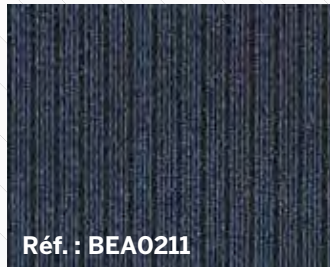

Réf. : BEA0211



Réf. : BEA0212

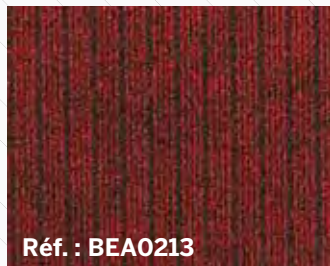

Réf. : BEA0213



Réf. : BEA0212

Largeur : 2 m
Épaisseur : 5 mm

1 995 F / m²

Soit 3 990 F le mètre



Cutter 99 E
+ 3 LAMES
OFFERTES
Réf. FSTA301

1 195 F



MOQUETTE GAZON

EXTÉRIEUR



Moquette gazon SQUASH

Épaisseur : 5 mm
Poids de velour : 340 gr/m²
Largeur : 4 m

1 395 F / m²

Soit 5 580 F le mètre linéaire
Réf. BEA0104



Moquette gazon SUMMER

Épaisseur : 7 mm
Poids de velour : 550 gr/m²
Largeur : 4 m

2 395 F / m²

Soit 9 580 F le mètre linéaire
Réf. BEA0107



Moquette gazon METIS

Épaisseur : 20 mm
Poids de velour : 490 gr/m²
Largeur : 4 m

2 790 F / m²

Soit 11 160 F le mètre linéaire
Réf. SOMP101



Moquette gazon SOFT

Épaisseur : 25 mm
Poids de velour : 328 gr/m²
Largeur : 4 m

3 195 F / m²

Soit 12 780 F le mètre linéaire
Réf. SOMP102



Moquette gazon CHELSEA

Épaisseur : 35 mm
Poids de velour : 1 436 gr/m²
Largeur : 4 m

3 595 F / m²

Soit 14 380 F le mètre linéaire
Réf. SOMP103



Moquette gazon MOUTAIN CREEK

Épaisseur : 40 mm
Poids de velour : 1 510 gr/m²
Largeur : 4 m

3 995 F / m²

Soit 15 980 F le mètre linéaire
Réf. BEA0110





DALLE EXTÉRIEUR



Dalle KIKO
Grès cérame
60 x 60 cm
Épaisseur : 2 cm

6 930 F / m²

Vendu à la pièce
2 495 F le carreau



Réf. CAR2002

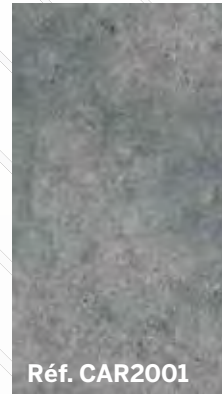

Réf. CAR2001

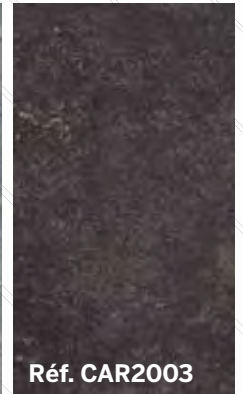

Réf. CAR2003



Plot réglable
Hauteur de 25 à 40 mm
avec espaceur 2,5 mm
Réf. CAR2015

795 F l'unité



Plot réglable
Hauteur de 39 à 65 mm
avec espaceur 3,5 mm
Réf. CAR2016

890 F l'unité

GALET POUR SOL



30 x 30 cm

6 495 F / m²

Vendu par carton
de 1 m² soit 11 pièces



Réf. SOMC901



Réf. SOMC903



Réf. SOMC902

Cermi joint color
Blanc ou gris
Sac de 25 kg
Réf. CERMI30

3 695 F



GRÈS CÉRAME

PLAQUE DE GALETS



DECK COMPOSITE

DECK COMPOSITE

Lame creuse
 Largeur : 13,5 cm
 Longueur : 280 cm
 Epaisseur : 2,5 cm

5 950 F / m²
 Soit 2 249 F la lame



Réf. DEC0203



Réf. DEC0206



Réf. DEC0201



Réf. DEC0202



Réf. DEC0207



Réf. DEC0205



Réf. DEC0204

EXTÉRIEUR

DECK RADIATA

Deck RADIATA traité CCAH3

5 995 F / m²



Scie circulaire
 ø 190 mm
 1 600 W
 Réf. AEG0123

24 990 F



Saturateur
 Blanchon
 1 L - 6 à 8 m²
 Réf. BLA0450 - 2 995 F
 5 L - 30 à 40 m²
 Réf. BLA0451 - 12 995 F
 20 L - 120 à 160 m²
 Réf. BLA0452 - 38 995 F

Disponible en
 coloris IPE et
 miel

à partir de 3 495 F

Dimension en cm	Longueur	Réf.	PRIX unitaire
Largeur 14 cm	4m20	DEC3009	3 525 F
	4m80	DEC3011	4 029 F
Épaisseur 3,2 cm	5m40	DEC3010	4 532 F



DECK RADIATA SANS NŒUD

Deck RADIATA sans nœud
traité LOSPH3

5 995 F / m²



Dimension en cm	Longueur	Réf.	PRIX unitaire
Largeur 14 cm Épaisseur 1,9 cm	3m	DEC3021	2 518 F
	3m60	DEC3022	3 022 F
	4m20	DEC3023	3 525 F

DECK MERBAU

Deck MERBAU

8 995 F / m²

Dimension en cm	Longueur	Réf.	PRIX unitaire
Largeur 14 cm Épaisseur 1,9 cm	1m80	DEC1001	2 267 F
	2m10	DEC1002	2 645 F
	2m40	DEC1003	3 022 F
	2m70	DEC1004	3 400 F
	3m	DEC1005	3 778 F
	3m30	DEC1006	4 155 F
	3m60	DEC1007	4 533 F
	3m90	DEC1008	4 911 F
	4m20	DEC1009	5 290 F
	4m50	DEC1010	5 667 F
	4m80	DEC1011	6 045 F
	5m10	DEC1012	6 423 F
	5m40	DEC1013	6 800 F
	5m70	DEC1014	7 178 F





PEINTURE

ACRYLIQUE

PRÉPARATION DES FONDS BLANC MAT



Cont.	Surface	Réf.	PRIX
5 L	40 m ²	DUR0112	3 995 F
25 Kg	125 m ²	DUR0101	7 995 F

FINITION BLANC MAT



Cont.	Surface	Réf.	PRIX
5 L	40 m ²	DUR0114	4 595 F
25 Kg	125 m ²	DUR0103	8 995 F

FINITION BLANC SATIN



Cont.	Surface	Réf.	PRIX
5 L	30 m ²	DUR0116	6 895 F
23 Kg	115 m ²	DUR0104	15 995 F

GLYCÉRO



Cont.	Surface	Réf.	PRIX
5 L	40 m ²	DUR0118	7 395 F
15 L	140 m ²	DUR0105	16 995 F



Cont.	Surface	Réf.	PRIX
5 L	40 m ²	DUR0120	7 695 F
15 L	130 m ²	DUR0106	17 995 F



Cont.	Surface	Réf.	PRIX
5 L	40 m ²	DUR0122	8 895 F
15 L	140 m ²	DUR0107	19 995 F

FAÇADE

SÉLECTION
SOMAC
MATÉRIAUX DE CONSTRUCTION



130 m²

Façade Pliolite
Blanc mat - Extérieur
15 L - Réf. DUR0108

16 995 F



125 m²

Mat Acrylique
Blanc mat
Intérieur / Extérieur
25 Kg - Réf. DUR0109

12 995 F



COLORANT



Colorant universel
100 ml

Colorant universel
250 ml



À partir de 2 295 F

CRÉPIS



Crépis intérieur extérieur
Seau de 15 Kg
Blanc - Réf. CRE0001
Ton pierre - Réf. CRE0002

2 290 F



Rouleau spécial crépis
Finition grain fin
Réf. PIN0123

995 F



Rouleau spécial crépis
Finition gros grain
Réf. PIN0112

1 995 F

PEINTURE SUR MESURE



La machine à teinter offre un choix incomparable de peintures extérieures ou intérieures, satinées, mates ou brillantes



1 400 couleurs au choix





PORTE EN BOIS

Finition Mahogany • HAUTEUR 204 cm - ÉPAISSEUR 3,7 cm

EXTÉRIEUR/INTÉRIEUR



PORTE PUKA PUKA

Larg. en cm	Réf.	PRIX
83	SOMB142	56 995 F



Modèle NAPUKA



PORTE NAPUKA

Larg. en cm	Réf.	PRIX
73	SOMB132	39 990 F
83	SOMB133	43 995 F
93	SOMB134	46 995 F



PORTE PUKARUA

Larg. en cm	Réf.	PRIX
73	SOMB147	39 990 F
83	SOMB148	43 995 F
93	SOMB149	46 995 F

LES BÂTIS MAHOGANY

1 TRAVERSE

Pour largeur : 73, 83 ou 93 cm

+ 2 MONTANTS

Hauteur : 215 cm

13 990 F

Réf. SOMB131



LE BÂTI ET LES PORTES SONT VENDUS SÉPARÉMENT

Le MAHOGANY est un bois exotique de bonne qualité qui fait concurrence à l'acajou.

Résistant bien à l'humidité, il est à favoriser pour la construction des portes sur le Fenua.

MAHOGANY



PORTE RAROIA

Larg. en cm	Réf.	PRIX
83	SOMB114	39 990 F
93	SOMB115	42 995 F



PORTE TEMOE

Larg. en cm	Réf.	PRIX
73	SOMB122	35 995 F
83	SOMB123	39 990 F
93	SOMB124	42 995 F

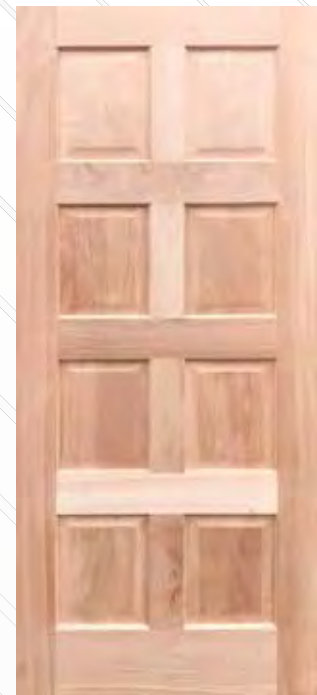

PORTE MAKEMO

Larg. en cm	Réf.	PRIX
73	SOMB110	35 995 F
83	SOMB111	39 990 F
93	SOMB112	42 995 F

EXTÉRIEUR/INTÉRIEUR

POINT INFO

Comment bien choisir et mesurer une porte ?

1. Sens d'ouverture

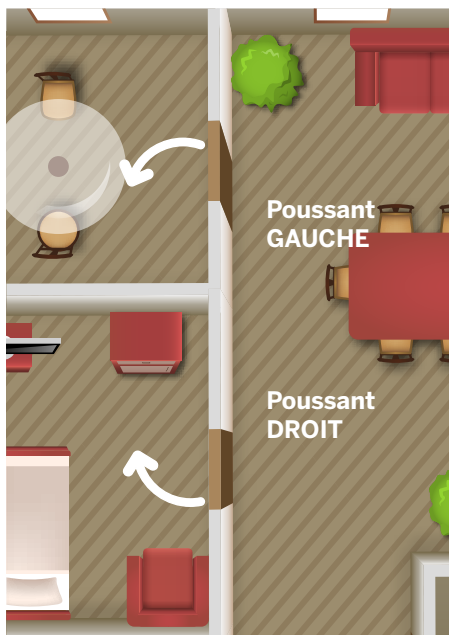

2. Prises de mesures - Largeur et profondeur



STANDARD - Dimensions en cm

BLOC PORTE MAHOGANY			PORTE		
Largeur	Hauteur	Épaisseur	Largeur	Hauteur	Épaisseur
80	208,5	6	73	204	3,7
90	208,5	6	83	204	3,7
100	208,5	6	93	204	3,7



PORTE EN BOIS

Finition Mahogany • HAUTEUR 204 cm - ÉPAISSEUR 3,7 cm

EXTÉRIEUR/INTÉRIEUR

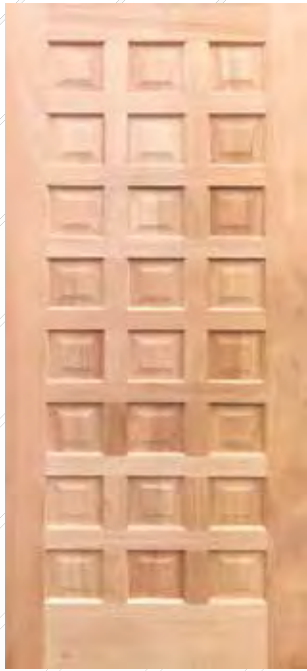

PORTE UA POU

Larg. en cm	Réf.	PRIX
83	SOMB129	39 990 F
93	SOMB130	42 995 F



PORTE FATU HIVA

Larg. en cm	Réf.	PRIX
73	SOMB125	35 995 F
83	SOMB126	39 990 F
93	SOMB127	42 995 F



PORTE TAHAA

Larg. en cm	Réf.	PRIX
73	SOMB107	35 995 F
83	SOMB108	39 990 F
93	SOMB109	42 995 F

INTÉRIEUR/EXTÉRIEUR



PORTE AHE

Larg. en cm	Réf.	PRIX
73	SOMB135	34 995 F
83	SOMB136	37 995 F
93	SOMB137	39 990 F

10 teintes

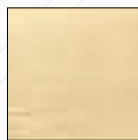

Incolor



Nature



Chêne clair



Chêne doré



Chêne moyen



Chêne rustique

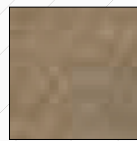

Chêne grisé



Teck



Blanc

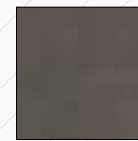

Gris vieilli

1 L 2,5 L 5 L 10 L

Lasure MATE OPTEM BLANCHON

Très riche en résines Aqua-polyuréthanes, la lasure d'un aspect mat, assure la protection microporeuse et hydrofuge de toutes boiseries extérieur et intérieurs de toutes essences.

1 litre - Réf. BLA0401 - **3 995 F**

2,5 litres - Réf. BLA0402 - **8 495 F**

5 litres - Réf. BLA0403 - **15 495 F**

10 litres (incolore) - Réf. BLA0404 - **26 490 F**

à partir de 3 995 F



Le MAHOGANY est un bois exotique de bonne qualité qui fait concurrence à l'acajou.
Résistant bien à l'humidité, il est à favoriser pour la construction des portes sur le Fenua.

MAHOGANY



PORTE MANIHI

Larg. en cm	Réf.	PRIX
73	SOMB119	34 995 F
83	SOMB120	37 995 F
93	SOMB121	39 990 F



PORTE TUPAI

Larg. en cm	Réf.	PRIX
73	SOMB116	34 995 F
83	SOMB117	37 995 F
93	SOMB118	39 990 F

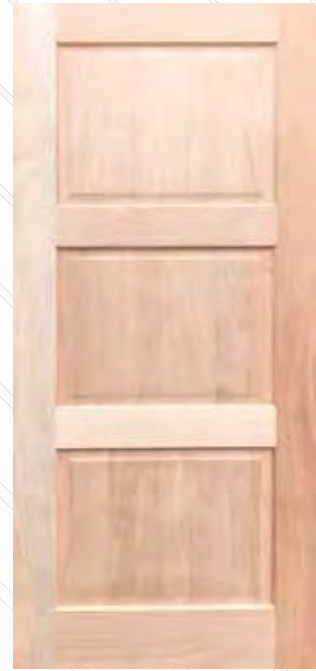

PORTE MAUPITI

Larg. en cm	Réf.	PRIX
73	SOMB144	34 995 F
83	SOMB145	37 995 F
93	SOMB146	39 990 F



PORTE MOOREA

Larg. en cm	Réf.	PRIX
73	SOMB101	37 995 F
83	SOMB102	42 995 F



PORTE MAIAO

Larg. en cm	Réf.	PRIX
73	SOMB138	37 995 F
83	SOMB139	42 995 F



PORTE ANAA

Larg. en cm	Réf.	PRIX
73	SOMB104	37 995 F
83	SOMB105	42 995 F

INTÉRIEUR/EXTÉRIEUR



POIGNÉE

HOPPE

La qualité bien en main.

INOX MAT



ALTA

Poignée + rosace	Réf.	PRIX
A - Cylindre (à clé)	HOP0190	1 995 F
B - Condamnation (à bouton)	HOP0191	3 395 F



DENVER

Poignée + rosace	Réf.	PRIX
A - Cylindre (à clé)	HOP0130	4 995 F
B - Condamnation (à bouton)	HOP0131	7 995 F



SAN FRANCISCO

Poignée + rosace	Réf.	PRIX
A - Cylindre (à clé)	HOP0180	9 995 F
B - Condamnation (à bouton)	HOP0181	12 990 F



ATHINAI

Poignée + rosace	Réf.	PRIX
A - Cylindre (à clé)	HOP0050	14 995 F
B - Condamnation (à bouton)	HOP0051	17 995 F



CAPRI

Poignée + rosace	Réf.	PRIX
A - Cylindre (à clé)	HOP0110	14 995 F
B - Condamnation (à bouton)	HOP0111	17 395 F



Modèle CAPRI

ALU CHROMÉ



Modèle BERGEN

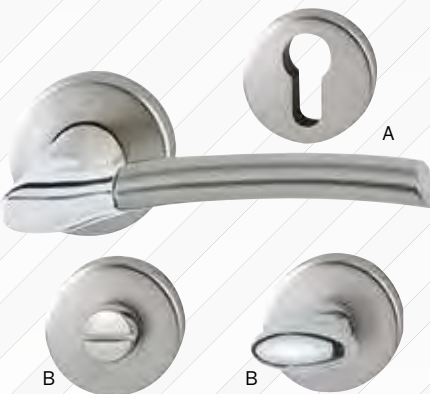

BERGEN

Poignée + rosace	Réf.	PRIX
A - Cylindre (à clé)	HOP0100	17 995 F
B - Condamnation (à bouton)	HOP0101	22 995 F



LOS ANGELES

Disponible en finition chromé satin

Poignée + rosace	Réf.	PRIX
A - Cylindre (à clé)	HOP0150	7 995 F
B - Condamnation (à bouton)	HOP0151	11 990 F



(A) Rosace pour cylindre à clé/clé ou clé/bouton

(B) Rosace à condamnation à bouton



Face 1



Face 2



(C) Rosace pour clé «L»



IBIZA

Poignée + rosace	Réf.	PRIX
A - Cylindre (à clé)	HOP0210	1 695 F
B - Condamnation (à bouton)	HOP0211	2 495 F



DUBLIN

Poignée + rosace	Réf.	PRIX
A - Cylindre (à clé)	HOP0200	1 995 F
B - Condamnation (à bouton)	HOP0201	2 790 F



DALLAS

Poignée + rosace	Réf.	PRIX
A - Cylindre (à clé)	HOP0120	6 995 F
B - Condamnation (à bouton)	HOP0121	8 295 F



ROTTERDAM

Poignée + rosace	Réf.	PRIX
A - Cylindre (à clé)	HOP0170	12 990 F
B - Condamnation (à bouton)	HOP0171	14 995 F



Modèle DALLAS



Modèle LOS ANGELES



ACAPULCO

Disponible en laiton finition satin

Poignée + rosace	Réf.	PRIX
C - À clé «L»	HOP0030	19 995 F
B - Condamnation (à bouton)	HOP0040	22 995 F

ALU ARGENTÉ

LAITON BRILLANT



PORTE EN BOIS

Finition Durian • HAUTEUR 204 cm - ÉPAISSEUR 3,7 cm

EXTÉRIEUR/INTÉRIEUR



PORTE UA POU

Larg. en cm	Réf.	PRIX
83	PAC0505	27 995 F
93	PAC0506	29 995 F



PORTE RAPA

Larg. en cm	Réf.	PRIX
83	PAC0517	27 995 F
93	PAC0518	29 995 F



PORTE TUBUAI

Larg. en cm	Réf.	PRIX
73	PAC0028	25 990 F
83	PAC0029	27 995 F



PORTE HIVA OA

Larg. en cm	Réf.	PRIX
83	PAC0502	27 995 F
93	PAC0503	29 995 F



PORTE MORANE

Larg. en cm	Réf.	PRIX
73	PAC0510	25 990 F
83	PAC0511	27 995 F
93	PAC0512	29 995 F



PORTE TEMOE

Larg. en cm	Réf.	PRIX
73	PAC0513	25 990 F
83	PAC0514	27 995 F
93	PAC0515	29 995 F

Les portes extérieures ou intérieures en bois DURIAN sont à traiter et colorer selon vos goûts ou à peindre selon vos humeurs. Elles sont résistantes aux intempéries et aux infractions. Le bois c'est la passion de l'élégance...

DURIAN

LES BÂTIS DURIAN

1 TRAVERSE

Pour largeur : 73, 83 ou 93 cm

+ 2 MONTANTS

Hauteur : 215 cm

12 990 F

Réf. PAC0001



LE BÂTI ET LES PORTES SONT VENDUS SÉPARÉMENT

THIRARD



Serrure 3 points à encastrer
modél TRIMAX
axe 50
Réf. FTH0127
Poignée vendue séparément.

16 395 F

POINT INFO

Comment choisir ses paumelles de porte ?

1. SÉLECTIONNER LA HAUTEUR

2 tailles au choix :

- 110 mm pour les portes alvéolaires
- 140 mm pour les portes pleines

2. DÉFINIR LE SENS D'OUVERTURE

POUSSANT GAUCHE
OU TIRANT DROIT

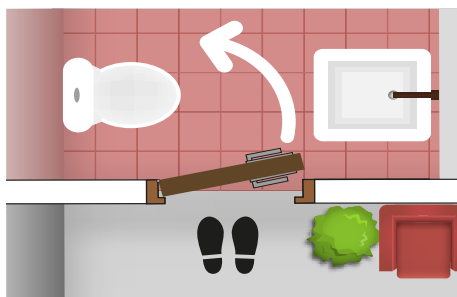

Ouverture vers la gauche
= paumelle gauche

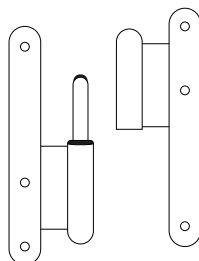

POUSSANT DROIT
OU TIRANT GAUCHE

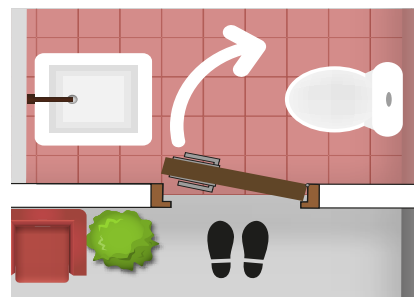

Ouverture vers la droite
= paumelle droite

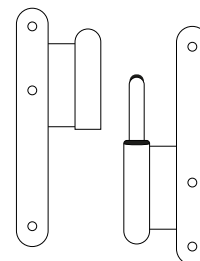

3. CHOISIR LA QUALITÉ

- INOX pour une meilleure tenue dans le temps
- ACIER ZINGUÉ pour un coût plus modeste

JARDINIER MASSARD®



Paumelle
inox
110 x 55 mm
Droite - Réf. JAR0016 - 795 F
Gauche - Réf. JAR0015 - 795 F

140 x 55 mm
Droite - Réf. JAR0018 - 995 F
Gauche - Réf. JAR0017 - 995 F

à partir de 795 F

JARDINIER MASSARD®



Paumelle
zinguée
110 x 55 mm
Gauche - Réf. JAR0011 - 295 F
Droite - Réf. JAR0012 - 295 F

140 x 55 mm
Gauche - Réf. JAR0013 - 390 F
Droite - Réf. JAR0014 - 390 F

à partir de 295 F

PAUMELLE



PORTE EN BOIS

Finition Durian • HAUTEUR 204 cm - ÉPAISSEUR 3,7 cm

INTÉRIEUR/EXTÉRIEUR



PORTE RURUTU

Larg. en cm	Réf.	PRIX
73	PAC0031	24 990 F
83	PAC0032	26 990 F



PORTE ARUTUA

Larg. en cm	Réf.	PRIX
73	PAC0034	24 990 F
83	PAC0035	26 990 F
93	PAC0036	28 995 F



PORTE HITI

Larg. en cm	Réf.	PRIX
73	PAC0519	24 990 F
83	PAC0520	26 990 F

POINT INFO

Comment bien choisir et mesurer une porte ?

1. Sens d'ouverture

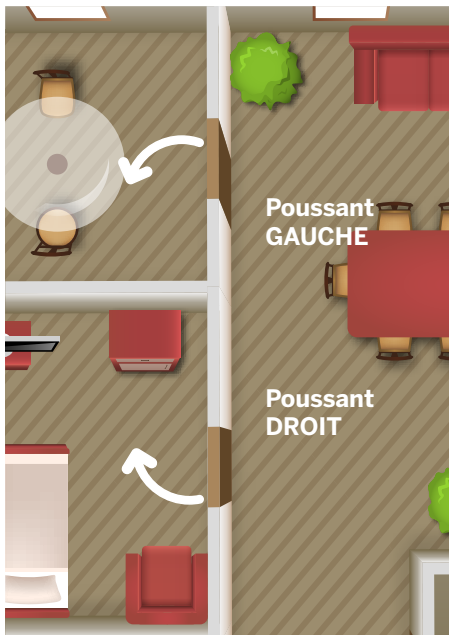

2. Prises de mesures - Largeur et profondeur



STANDARD - Dimensions en cm

BLOC PORTE DURIAN			PORTE		
Largeur	Hauteur	Épaisseur	Largeur	Hauteur	Épaisseur
81	209	9	73	204	3,7
91	209	9	83	204	3,7
101	209	9	93	204	3,7

Les portes extérieures ou intérieures en bois DURIAN sont à traiter et colorer selon vos goûts ou à peindre selon vos humeurs. Elles sont résistantes aux intempéries et aux infractions. Le bois c'est la passion de l'élégance...

DURIAN



POINT INFO

Dimensions d'une porte finition DURIAN

(en mm)

Bloc porte = porte + bâti

Largeur

Porte : 730, 830 ou 930
Bloc porte : 810, 910 ou 1 010

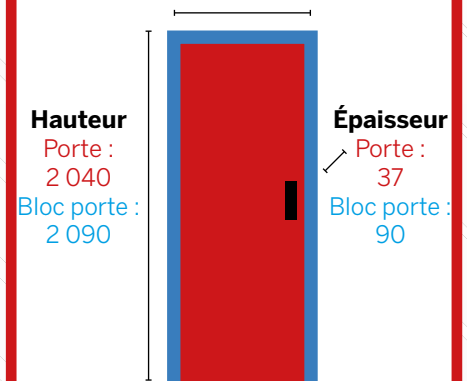

INTÉRIEUR/EXTÉRIEUR



PORTE MAIAO

Larg. en cm	Réf.	PRIX
73	PAC0022	24 990 F
83	PAC0023	26 990 F



PORTE TUPAI

Larg. en cm	Réf.	PRIX
73	PAC0013	24 990 F
83	PAC0014	26 990 F
93	PAC0015	28 995 F

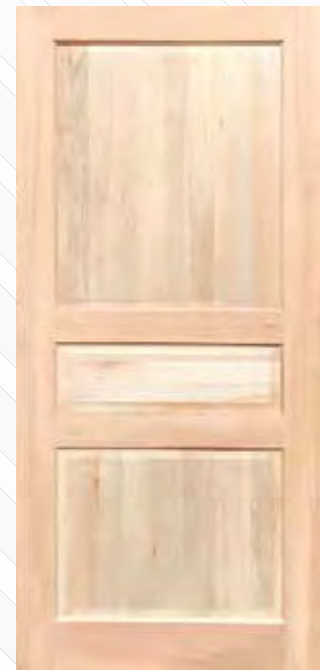

PORTE MANIHI

Larg. en cm	Réf.	PRIX
73	PAC0010	24 990 F
83	PAC0011	26 990 F
93	PAC0012	28 995 F



POIGNÉE



ALUMINIUM MAT



ENSEMBLE BUDGET

Plaque	Réf.	PRIX
A - Cylindre (à clé)	VAC0061 - ARGENT	995 F
	VAC0063 - CHAMPAGNE	
B - Condamnation (à bouton)	VAC0062 - ARGENT	1 295 F
	VAC0064 - CHAMPAGNE	



LOGIO - ARGENT

Rosace	Réf.	PRIX
A - Cylindre (à clé)	VAC0086	4 495 F
B - Condamnation (à bouton)	VAC0087	5 295 F

INOX BROSSÉ



LINOX 492 - INOX

Rosace	Réf.	PRIX
A - Cylindre (à clé)	VAC0020	2 495 F
	VAC0025	850 F
B - Condamnation (à bouton)	VAC0020	2 495 F
	VAC0026	1 745 F



LINOX 494 - INOX

Rosace	Réf.	PRIX
A - Cylindre (à clé)	VAC0010	2 495 F
	VAC0025	850 F
B - Condamnation (à bouton)	VAC0010	2 495 F
	VAC0026	1 745 F



Modèle SCULT

ZAMAK



JAZZ - ARGENT

Rosace	Réf.	PRIX
A - Cylindre (à clé)	VAC0080	8 295 F
B - Condamnation (à bouton)	VAC0081	10 990 F



ARTIS - ARGENT

Rosace	Réf.	PRIX
A - Cylindre (à clé)	VAC0093	6 395 F
	VAC0094	3 195 F
B - Condamnation (à bouton)	VAC0093	6 395 F
	VAC0095	3 995 F



SCULT - ARGENT

Rosace	Réf.	PRIX
A - Cylindre (à clé)	VAC0100	7 895 F
	VAC0101	2 895 F
B - Condamnation (à bouton)	VAC0100	7 895 F
	VAC0102	3 595 F



EN 1154	Poids Porte	Larg. Porte
	65 kg max.	950 mm max.

Ferme porte coupe-feu modèle DC135
En applique à bras glissière
Coloris argent
Réf. VAC0204

17 690 F

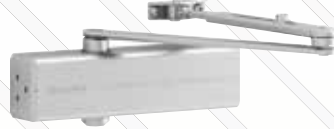

EN 1154	Poids Porte	Larg. Porte
	85 kg max.	1 100 mm max.

Ferme porte coupe-feu modèle 140
En applique à bras compas
Coloris argent
Réf. VAC0203

12 390 F

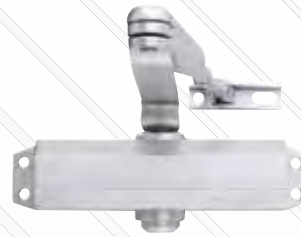

EN 1154	Poids Porte	Larg. Porte
	85 kg max.	950 mm max.

Ferme porte coupe-feu modèle DC110
En applique à bras compas
Coloris argent
Réf. VAC0207

6 995 F



EN 1154	Poids Porte	Larg. Porte
	65 kg max.	950 mm max.

Ferme porte coupe-feu modèle 135PI
En applique à bras compas
Coloris argent
Réf. VAC0211

12 990 F

**SÉLECTION
SOMAC**
MATÉRIEL DE CONSTRUCTION



Poids Porte	Larg. Porte
85 kg max.	1 110 mm max.

Ferme porte coupe-feu modèle 777
En applique à bras compas
Coloris argent - Réf. AMI0587
Coloris doré - Réf. AMI0588
Coloris bronze - Réf. AMI0589
Coloris blanc - Réf. AMI0594

6 995 F

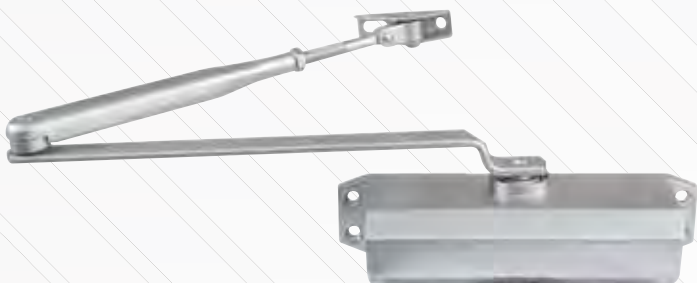

EN 1154	Poids Porte	Larg. Porte
	85 kg max.	1 110 mm max.

Ferme porte coupe-feu modèle 799
En applique à bras compas
Coloris argent
Réf. AMI0596

9 670 F



Poids Porte	Larg. Porte
85 kg max.	1 110 mm max.

Ferme porte modèle 775
En applique à bras compas
Coloris argent
Réf. AMI0597

5 650 F



Poids Porte	Larg. Porte
85 kg max.	1 110 mm max.

Ferme porte modèle 775
En applique à bras compas
Coloris blanc
Réf. AMI0598

5 650 F



SERRURE À LARDER Réversible

VACHETTE

AXE 50



Modèle A455
Inox
Serrure - Réf. VAC0221 - 2 895 F
Gache - Réf. VAC0227 - 211 F

3 106 F l'ensemble



Modèle
Laiton
Serrure + gache
Réf. VAC0224

3 290 F



Modèle
Inox
Serrure - Réf. VAC0225 - 2 995 F
Gache - Réf. VAC0026 - 1 735 F

4 730 F l'ensemble



Modèle D455UR
Inox
Serrure - Réf. VAC0222 - 1 595 F
Gache - Réf. VAC0228 - 195 F

1 790 F l'ensemble

AMIG



Modèle NIZA 911
Laiton
Serrure + gache
Réf. AMI0048

1 795 F

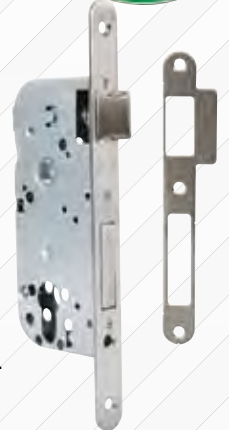
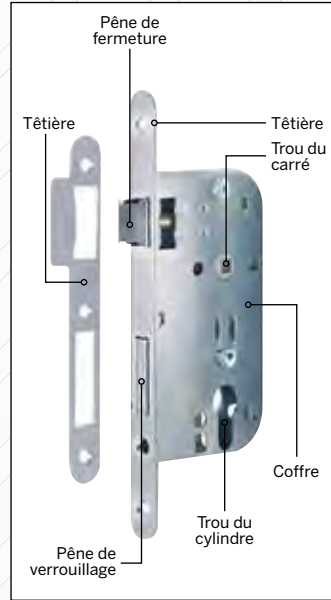

Modèle NIZA 911
Laiton
Serrure + gache
Réf. AMI0047

1 595 F

THIRARD



Modèle
Inox
Serrure + gache
Réf. FTH0117

2 395 F



Modèle
Inox
Serrure condamnation + gache
Réf. FTH0118

2 790 F



Modèle
Inox
Serrure cylindre + gache
Réf. FTH0122

2 895 F



Modèle
Inox
Serrure cylindre + gache
Réf. FTH0116

2 895 F



POINT INFO

Comment bien choisir son cylindre de serrure ?

Fermer une porte d'entrée à clé, de l'intérieur comme de l'extérieur, sécuriser un sellier de l'intérieur de la maison sans pour autant risquer de s'y enfermer, ou encore ouvrir son garage d'un simple tour de poignée et le fermer à clé en partant... Tout dépend du cylindre. Partie visible de la serrure, il est l'élément principal qui détermine le type d'ouverture et le niveau de sécurité recherché.

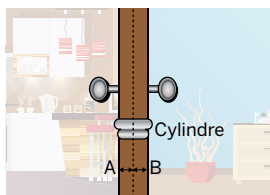

MESURER UN CYLINDRE

La longueur se mesure depuis le centre du trou de fixation (panneton) jusqu'aux extrémités intérieure et extérieure du cylindre (A et B).



CYLINDRE CLASSIQUE

Il se reconnaît grâce aux **2 entrées de la clé**, pour ouvrir la porte des deux côtés.

Lorsqu'une clé est engagée d'un côté, le cylindre ne peut être actionné de l'autre côté.



CYLINDRE À BOUTON

C'est un cylindre débrayable, dont l'entrée de la clé coté intérieur a été remplacée par un bouton.

Il peut donc **toujours être ouvert d'un côté, sans utiliser de clé.**

NICKEL



Clé/Clé - 30 x 30
Réf. VAC0320

1 295 F

LAITON

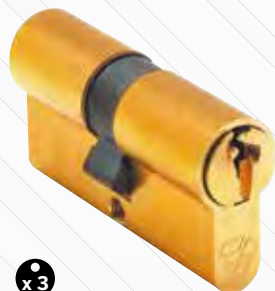

Clé/Clé - 30 x 30
Réf. VAC0330

1 295 F

CHROMÉ MAT



Modèle 9700
Clé/Clé - 30 x 30
Réf. AMI0057

2 695 F

LAITON MAT



Modèle 9700
Clé/Clé - 30 x 30
Réf. AMI0058

2 695 F

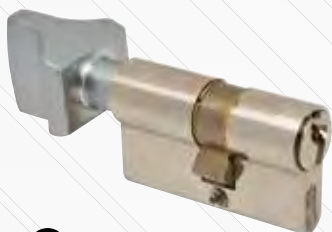

Clé/Bouton - 30 x 30
Réf. VAC0325

2 595 F



Clé/Bouton - 30 x 30
Réf. VAC0335

2 595 F



Modèle 9700
Clé/Bouton - 30 x 30
Réf. AMI0055

2 995 F



Modèle 9700
Clé/Bouton - 30 x 30
Réf. AMI0056

2 995 F

CLÉ/CLÉ

CLÉ/BOUTON



PORTE EN BOIS

Méranti • HAUTEUR 204 cm - ÉPAISSEUR 3,7 cm

POINT INFO

Comment bien mesurer une porte ?

Prises de mesures - Largeur et profondeur

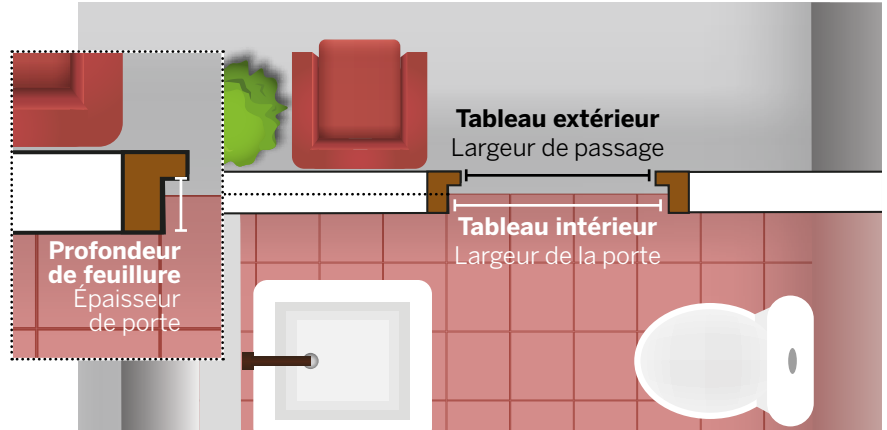

STANDARD - Dimensions en cm

BLOC PORTE MÉRANTI			PORTE		
Largeur	Hauteur	Épaisseur	Largeur	Hauteur	Épaisseur
80	208,5	6	73	204	3,7
90	208,5	6	83	204	3,7
100	208,5	6	93	204	3,7



PORTE NAPUKA

Larg. en cm	Réf.	PRIX
73	SOMB332	39 990 F
83	SOMB333	43 995 F
93	SOMB334	46 995 F

EXTÉRIEUR/INTÉRIEUR

LES BÂTIS MÉRANTI

1 TRAVERSE

Largeur : 73, 83 ou 93 cm

+ 2 MONTANTS

Hauteur : 215 cm

12 990 F



73 - Réf. SOMB339
83 - Réf. SOMB340
93 - Réf. SOMB341

LE BÂTI ET LES PORTES SONT
VENDUS SÉPARÉMENT



PORTE MAKEMO

Larg. en cm	Réf.	PRIX
73	SOMB310	35 995 F
83	SOMB311	39 990 F
93	SOMB312	42 995 F

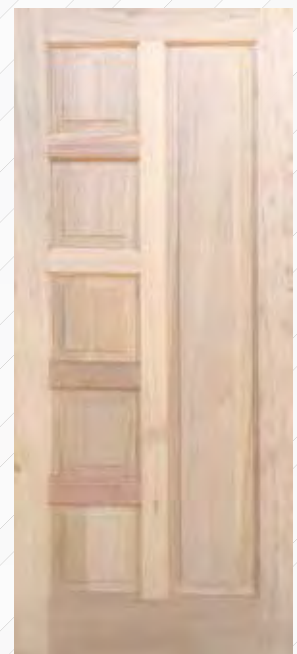

PORTE FATU HIVA

Larg. en cm	Réf.	PRIX
83	SOMB326	39 990 F
93	SOMB327	42 995 F

Le MÉRANTI est un bois exotique ne présentant pas de nœud. Il a une bonne stabilité, il assure une bonne isolation thermique et un bon niveau de sécurité.

MÉRANTI

POINT INFO

Comment bien choisir une porte ?

Sens d'ouverture

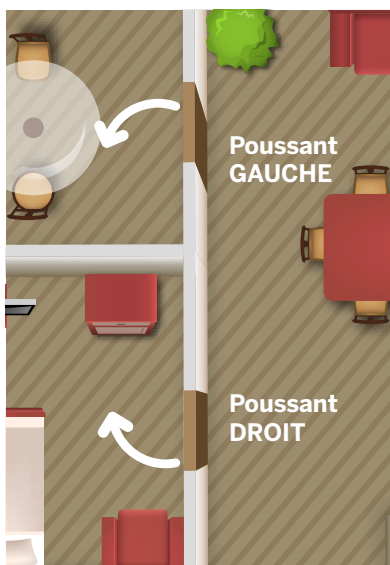

PORTE UA POU

Larg. en cm	Réf.	PRIX
83	SOMB329	39 990 F
93	SOMB330	42 995 F

PORTE RAROA

Larg. en cm	Réf.	PRIX
83	SOMB313	39 990 F
93	SOMB314	42 995 F



PORTE TEMOE

Larg. en cm	Réf.	PRIX
73	SOMB322	35 995 F
83	SOMB323	39 990 F
93	SOMB324	42 995 F



Modèle TEMOE

EXTÉRIEUR/INTÉRIEUR

INTÉRIEUR/EXTÉRIEUR



PORTE EN BOIS

Méranti • HAUTEUR 204 cm - ÉPAISSEUR 3,7 cm

EXTÉRIEUR / INTÉRIEUR



Modèle TAHAA

PORTE TAHAA

Larg. en cm	Réf.	PRIX
73	SOMB307	35 995 F
83	SOMB308	39 990 F
93	SOMB309	42 995 F

INTÉRIEUR / EXTÉRIEUR

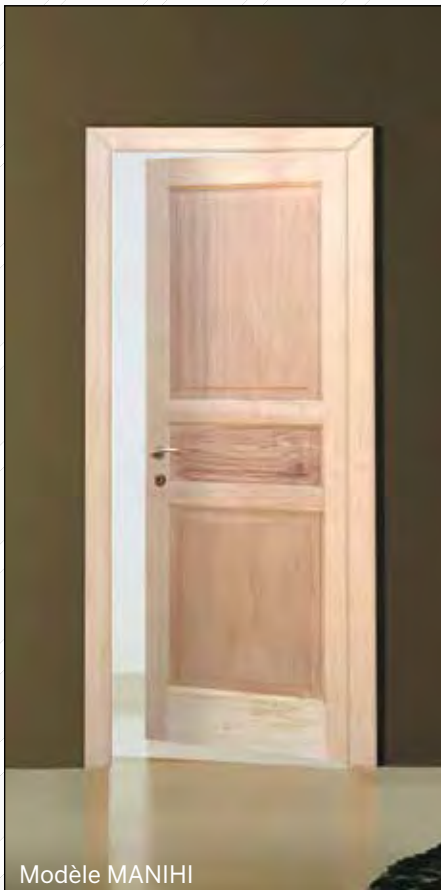

Modèle MANIHI



PORTE TUPAI

Larg. en cm	Réf.	PRIX
73	SOMB316	34 995 F
83	SOMB317	37 995 F

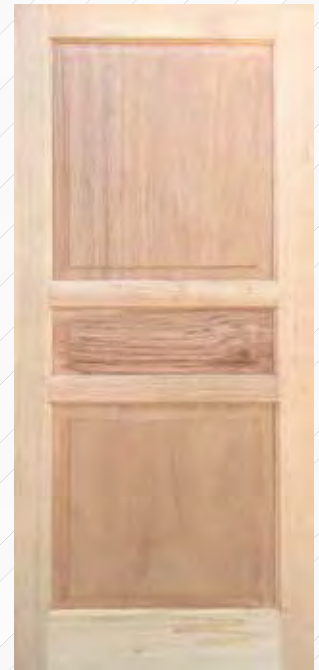

PORTE MANIHI

Larg. en cm	Réf.	PRIX
73	SOMB319	34 995 F
83	SOMB320	37 995 F

Le MÉRANTI est un bois exotique ne présentant pas de nœud. Il a une bonne stabilité, il assure une bonne isolation thermique et un bon niveau de sécurité.

MÉRANTI



PORTE AHE

Larg. en cm	Réf.	PRIX
73	SOMB335	34 995 F
83	SOMB336	37 995 F
93	SOMB337	39 990 F



Modèle AHE

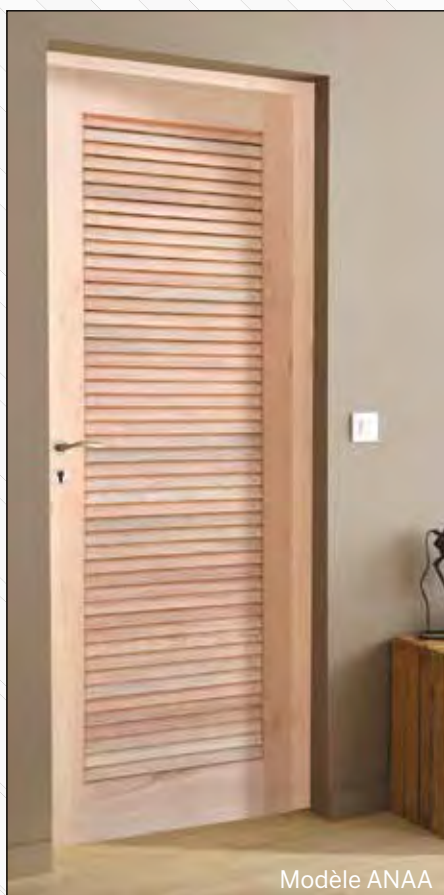

Modèle ANAA



PORTE MOOREA

Larg. en cm	Réf.	PRIX
73	SOMB301	36 995 F
83	SOMB302	41 995 F

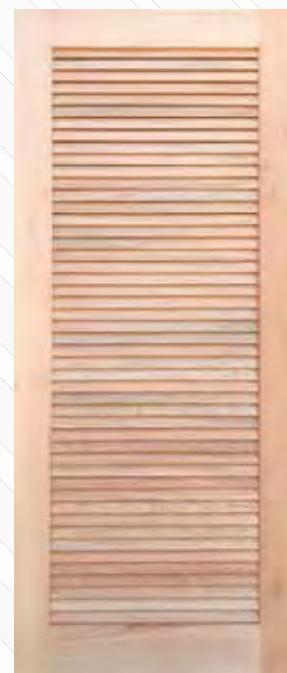

PORTE ANAA

Larg. en cm	Réf.	PRIX
73	SOMB304	36 995 F
83	SOMB305	41 995 F

INTÉRIEUR / EXTÉRIEUR



BOUTON DE PORTE SERRURE TUBULAIRE



BOUTON DE PORTE / SERRURE TUBULAIRE

MODÈLE 60



Finition	Clé/condamnation	PRIX	Condamnation	PRIX	Bec de canne	PRIX
CHROMÉ MAT	AMI0303	2 995 F	AMI0302	2 495 F	AMI0301	1 995 F
LAITON VIEILLI	AMI0315		AMI0314		AMI0313	
LAITON MAT	AMI0309		AMI0308		AMI0307	
ACIER INOXYDABLE	AMI0322	3 495 F	AMI0321	2 895 F	AMI0320	2 290 F

MODÈLE 61



Finition	Clé/condamnation	PRIX	Condamnation	PRIX	Bec de canne	PRIX
CHROMÉ MAT	AMI0353	2 995 F	AMI0352	2 495 F	AMI0351	1 995 F
LAITON VIEILLI	AMI0365		AMI0364		AMI0363	
LAITON MAT	AMI0362		AMI0361		AMI0360	
EPOXY NOIR	AMI0374		AMI0373		AMI0372	
EPOXY BLANC	AMI0377		AMI0376		AMI0375	
ACIER INOXYDABLE	AMI0371	3 495 F	AMI0370	2 895 F	AMI0369	3 290 F

VERROU TUBULAIRE



Finition	Clé/clé	PRIX	Clé/condamnation	PRIX	Condamnation	PRIX
CHROMÉ MAT	AMI0502	2 995 F	AMI0501	2 695 F	AMI0515	1 495 F
LAITON VERNI	AMI0506		AMI0505		AMI0517	
LAITON VIEILLI	AMI0510		AMI0509		AMI0516	

ACCESSOIRE

BÉQUILLE DE PORTE SERRURE TUBULAIRE



MODÈLE 70



Finition	Clé/condamnation	PRIX	Condamnation	PRIX	Bec de canne	PRIX
CHROMÉ MAT	Droite - AMI0454 Gauche - AMI0455	3 495 F	Droite - AMI0452 Gauche - AMI0453	3 195 F	AMI0451	2 995 F
LAITON VERNI	Droite - AMI0460 Gauche - AMI0461		Droite - AMI0458 Gauche - AMI0459		AMI0457	
LAITON VIEILLI	Droite - AMI0466 Gauche - AMI0467		Droite - AMI0464 Gauche - AMI0465		AMI0463	

MODÈLE 71



Finition	Clé/condamnation	PRIX	Condamnation	PRIX	Bec de canne	PRIX
CHROMÉ MAT	Droite - AMI0484 Gauche - AMI0485	3 495 F	Droite - AMI0482 Gauche - AMI0483	3 195 F	AMI0481	2 995 F
LAITON VERNI	Droite - AMI0490 Gauche - AMI0491		Droite - AMI0488 Gauche - AMI0489		AMI0487	
LAITON VIEILLI	Droite - AMI0496 Gauche - AMI0497		Droite - AMI0494 Gauche - AMI0495		AMI0493	

JUDAS



Laiton verni



Laiton vieilli

Modèle 2
Chromé brillant - Réf. AMI0553
Laiton verni - Réf. AMI0554
Laiton vieilli - Réf. AMI0555

995 F

BLOC PORTE



Modèle 11
Nickel mat - Réf. AMI0561
Doré - Réf. AMI0562

1 295 F

BUTOIR PORTE



Modèle 4
Nickel mat - Réf. AMI0570
Doré - Réf. AMI0569

1 295 F

BÉQUILLE DE PORTE / SERRURE TUBULAIRE

ACCESSOIRE



BÂTI ET PAUMELLE

DISPONIBLE EN 7 FINITIONS DIFFÉRENTES



Mahogany



Durian



Méranti



Sapeli



Hêtre



Sapin du nord
Prépeint



Sapin du nord



Essence	Larg. de porte	Réf.	PRIX
MAHOGANY	73	SOMB131	13 990 F
	83	SOMB131	
	93	SOMB131	
DURIAN	73	PAC0001	12 990 F
	83	PAC0001	
	93	PAC0001	
MÉRANTI	73	SOMB339	12 990 F
	83	SOMB340	
	93	SOMB341	
SAPELI	73	POR0438	18 870 F
	83	POR0439	19 075 F
	93	POR0440	19 480 F
HÊTRE	73	POR0430	13 485 F
	83	POR0431	13 675 F
	93	POR0432	13 885 F
SAPIN DU NORD PRÉPEINT	73	POR0413	7 590 F
	83	POR0414	7 695 F
	93	POR0415	7 995 F
SAPIN DU NORD	73	POR0180	6 880 F
	83	POR0181	6 970 F
	93	POR0182	7 175 F

LE BÂTI ET LES PORTES SONT VENDUS SÉPARÉMENT

ACIER ZINGUÉ



Paumelle zinguée
110 x 55 mm
Gauche - Réf. JAR0011 - **295 F**
Droite - Réf. JAR0012 - **295 F**

140 x 55 mm
Gauche - Réf. JAR0013 - **390 F**
Droite - Réf. JAR0014 - **390 F**

à partir de 295 F

INOX



Paumelle inox
110 x 55 mm
Droite - Réf. JAR0016 - **795 F**
Gauche - Réf. JAR0015 - **795 F**

140 x 55 mm
Droite - Réf. JAR0018 - **995 F**
Gauche - Réf. JAR0017 - **995 F**

à partir de 795 F

BÂTI

PAUMELLE



Poids Porte
40 kg
max.

CADETTE 185

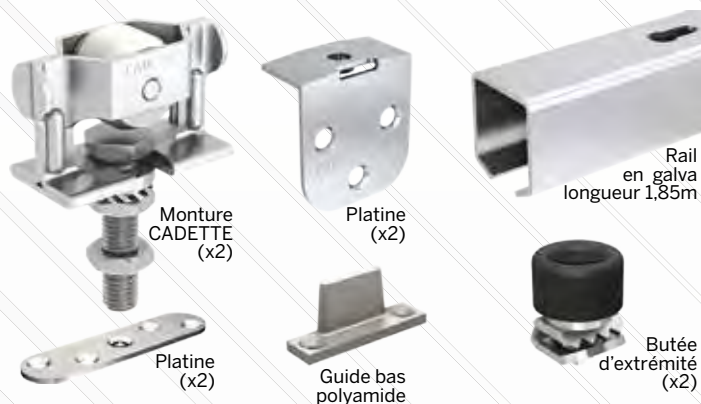

Réf. MAN1010

4 995 F le kit complet



Poids Porte
40 kg
max. **Fermeture avec ralentisseur**

SAF 40 A

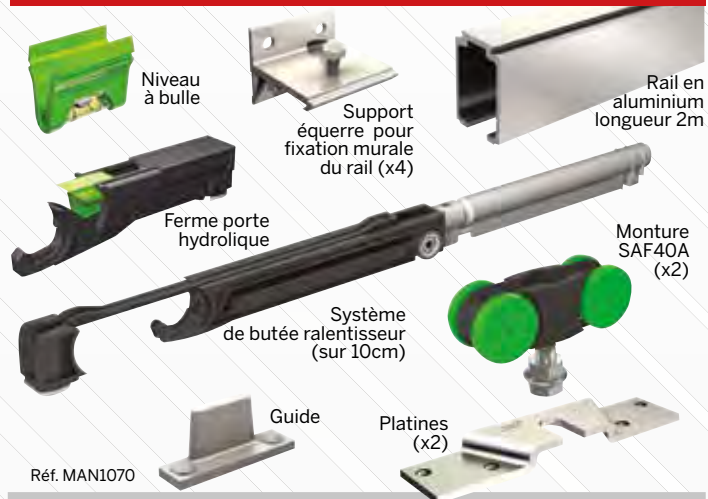

Réf. MAN1070

14 995 F le kit complet

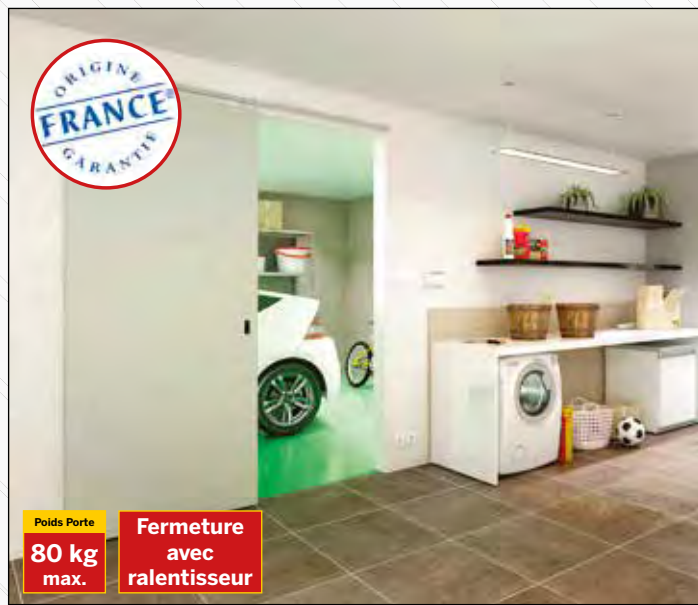

Poids Porte
80 kg
max. **Fermeture avec ralentisseur**

SAF 80 A

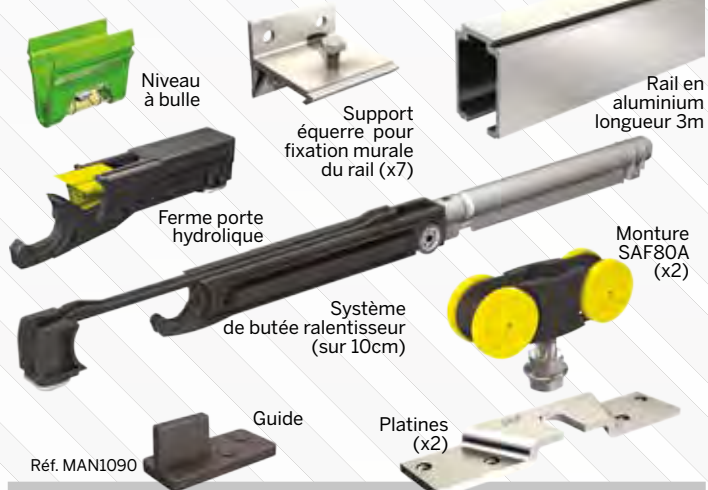

Réf. MAN1090

19 995 F le kit complet



PORTE INTÉRIEURE

PORTE POST-FORMÉE • Hauteur 204 cm - Épaisseur 4 cm

FINITION STRUCTURÉE

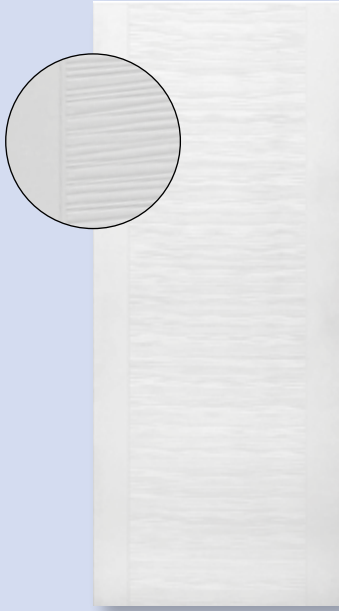

PORTE LATTITUDE

Larg. en cm	Réf.	PRIX
73	POR0306	14 495 F
83	POR0307	14 695 F

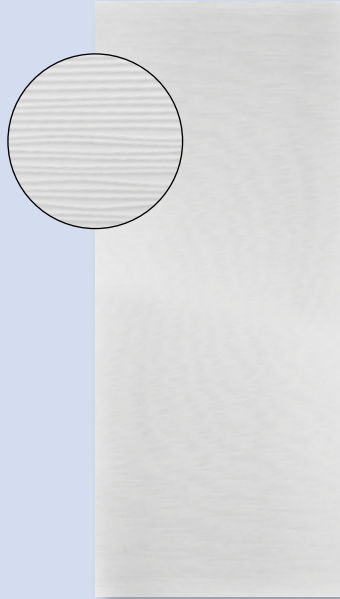

PORTE AMBIANCE

Larg. en cm	Réf.	PRIX
73	POR0297	14 495 F
83	POR0298	14 695 F
93	POR0299	19 670 F



TENDANCE

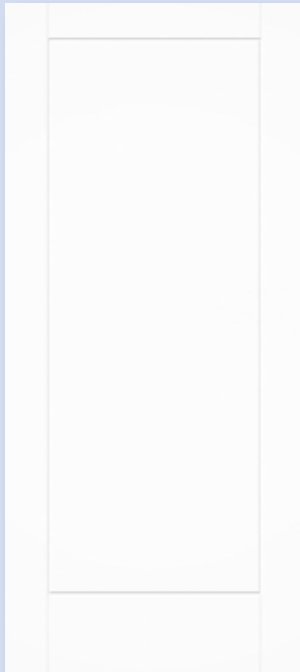

PORTE ÉLÉGANCE

Larg. en cm	Réf.	PRIX
73	POR0288	11 195 F
83	POR0289	11 990 F
93	POR0290	12 990 F



Modèle LADDER

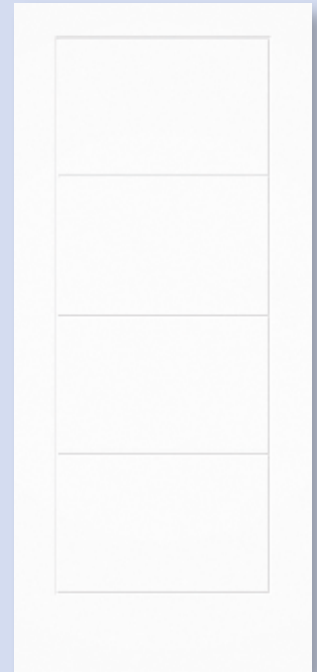

PORTE LADDER

Larg. en cm	Réf.	PRIX
73	POR0279	11 195 F
83	POR0280	11 990 F
93	POR0281	12 990 F

Deux parements en fibre de bois haute densité sont mis en forme d'une seule pièce par thermoformage. Ils ont l'apparence d'une porte à panneaux en bois massif tout en évitant ses contraintes (poids, dilatation et entretien).

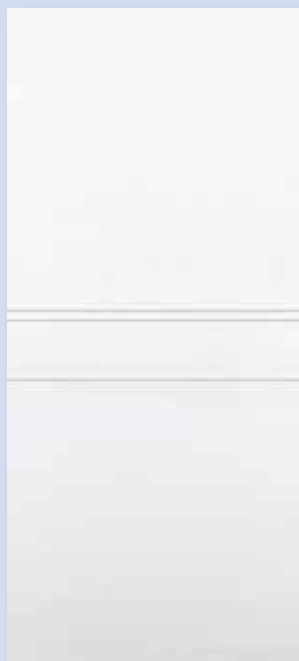

PORTE ANGLET

Larg. en cm	Réf.	PRIX
73	POR0333	14 495 F
83	POR0334	14 695 F



Modèle ESCALE

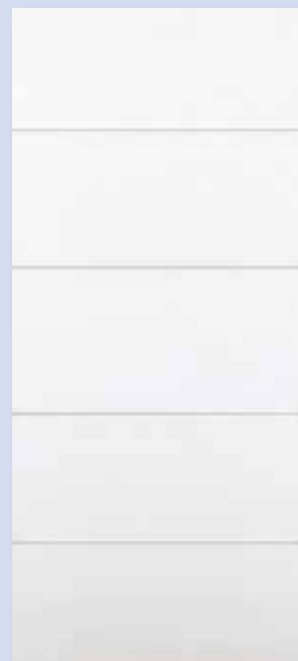

PORTE ESCALE

Larg. en cm	Réf.	PRIX
73	POR0315	14 495 F
83	POR0316	14 695 F
93	POR0317	21 020 F

MATRICÉE



Modèle ARCTIQUE

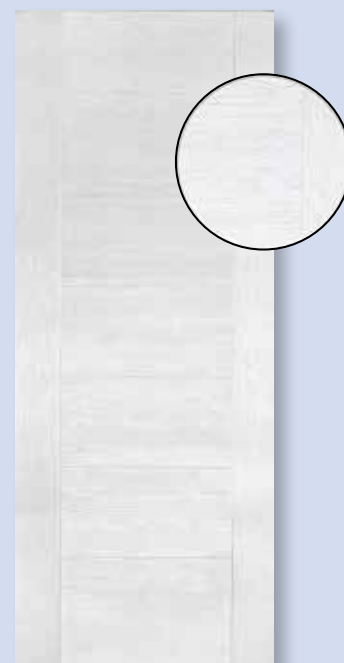

PORTE ARCTIQUE

Larg. en cm	Réf.	PRIX
73	POR0324	14 495 F
83	POR0325	14 695 F

FINITION GIVRÉE



PORTE INTÉRIEURE POSTFORMÉE

FINITION LISSE



Modèle PALACIO



PORTE NEFERTARI

Larg. en cm	Réf.	PRIX
73	POR0224	8 995 F
83	POR0225	9 995 F
93	POR0226	11 490 F



PORTE PALACIO

Larg. en cm	Réf.	PRIX
73	POR0270	9 990 F
83	POR0271	11 490 F
93	POR0272	11 990 F

POINT INFO

Comment bien choisir et mesurer une porte ?

1. Sens d'ouverture

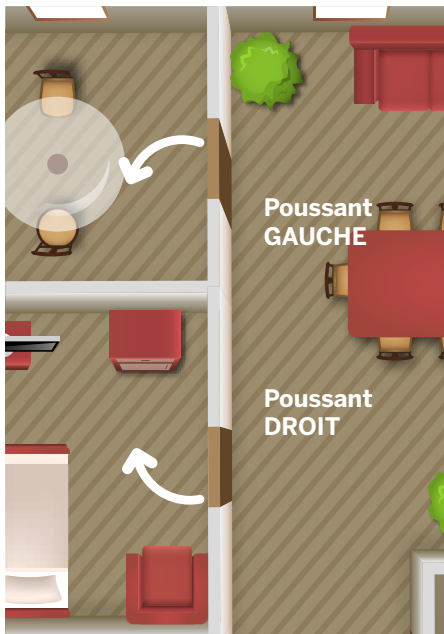

2. Prises de mesures - Largeur et profondeur

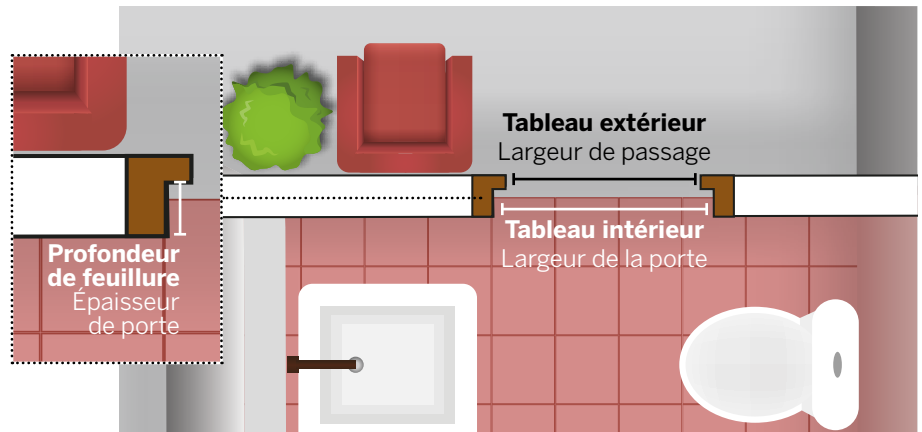

STANDARD - Dimensions en cm

Larg. bloc	Haut. bloc	Épais. bloc	Larg. porte	Haut. porte	Épais. porte
81	209	6,8	73	2 04	4
91	209	6,8	83	2 04	4
101	209	6,8	93	2 04	4

Deux parements en fibre de bois haute densité sont mis en forme d'une seule pièce par thermoformage. Ils ont l'apparence d'une porte à panneaux en bois massif tout en évitant ses contraintes (poids, dilatation et entretien).



PORTE MYKERINOS

Larg. en cm	Réf.	PRIX
73	POR0215	8 995 F
83	POR0216	9 995 F
93	POR0217	11 490 F



PORTE CHAPEAU DE GENDARME

Larg. en cm	Réf.	PRIX
73	POR0218	8 995 F
83	POR0219	9 995 F
93	POR0220	11 490 F

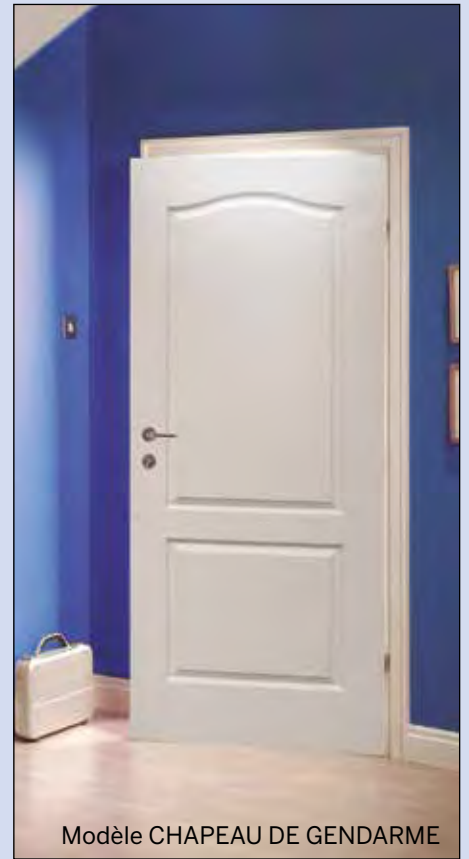

Modèle CHAPEAU DE GENDARME



Modèle MYKERINOS



PORTE PLANTATION

Larg. en cm	Réf.	PRIX
73	POR0221	8 995 F
83	POR0222	9 995 F
93	POR0223	11 490 F



PORTE ARCACHON

Larg. en cm	Réf.	PRIX
73	POR0078	8 995 F
83	POR0079	9 995 F

FINITION VEINÉE



PORTE INTÉRIEURE ISOPLANE

FINITION PRÉ-PEINT

PORTE ISOPLANE ALVÉOLAIRE • Hauteur 204 cm - Épaisseur 4 cm

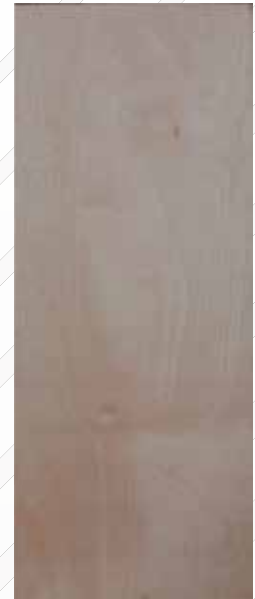

Ces modèles standard sont appropriés à une utilisation en intérieur. Les portes sont appelées alvéolaires en raison d'une structure nid d'abeille en carton renforcé enfermée dans un cadre en sapin. Elles sont à lasurer pour garder l'effet du bois naturel.

PORTE FPP ALVÉOLAIRE

Larg. en cm	Réf.	PRIX
73	POR0005	5 895 F
83	POR0006	6 190 F
93	POR0049	6 895 F

PORTE CP ALVÉOLAIRE

Larg. en cm	Réf.	PRIX
73	POR0001	7 995 F
83	POR0002	8 195 F
93	POR0050	8 795 F

FINITION CP

PORTE ISOPLANE ÂME PLEINE • Hauteur 204 cm - Épaisseur 4 cm



Les portes et bloc-portes à âme pleine en finition CP peuvent être utilisés en extérieur comme en intérieur. Ils peuvent être peints ou lasurés pour garder l'effet du bois.

PORTE CP ÂME PLEINE

Larg. en cm	Réf.	PRIX
73	POR0068	13 995 F
83	POR0003	14 995 F
93	POR0004	16 995 F

BLOC PORTE COUPE-FEU



Le choix du degré
de coupe-feu dépend
de la réglementation
en vigueur.



Les portes coupe-feu relèvent de la protection passive contre l'incendie en participant au cloisonnement des locaux, principe qui vise à limiter la propagation du feu, des fumées et des gaz toxiques entre les différentes parties du bâtiment. Ce cloisonnement a plusieurs objectifs, notamment donner un délai aux services d'intervention pour arriver sur le site et maîtriser le feu.

BLOC PORTE COUPE-FEU Ei30 (1/2 HEURE)

Dimension en cm	Sens ouverture	Réf.	PRIX
Porte 83	Gauche	POR0260	35 690 F
Bloc : 91 x 209	Droit	POR0261	
Porte 93	Gauche	POR0262	39 895 F
Bloc : 101 x 209	Droit	POR0263	

BLOC PORTE COUPE-FEU Ei60 (1 HEURE)

Dimension en cm	Sens ouverture	Réf.	PRIX
Porte 83	Gauche	POR0264	79 995 F
Bloc : 91 x 209	Droit	POR0265	
Porte 93	Gauche	POR0266	82 495 F
Bloc : 101 x 209	Droit	POR0267	

BARRE ANTI-PANIQUE

Vachette®
ASSA ABLOY



Modèle 6510BM
Alpha
1 point
Réf. VAC0251

19 995 F

Vachette®
ASSA ABLOY



Modèle 6530BM
Alpha
3 points
Réf. VAC0252

39 990 F

Vachette®
ASSA ABLOY



Modèle 1610BM
Push-touch
1 point
Réf. VAC0260

24 990 F

Vachette®
ASSA ABLOY



Modèle 1610BM
Push-touch
3 points
Réf. VAC0265

49 995 F

POIGNÉE ET CYLINDRE

Vachette®
ASSA ABLOY



Poignée module
Alpha
Extérieur
Réf. VAC0254

8 495 F

Vachette®
ASSA ABLOY



Demi cylindre 30x10
pour poignée modèle Alpha
Réf. VAC0255

2 695 F

BLOC PORTE TECHNIQUE



MENUISERIE ALUMINIUM

ÉPAISSEUR DU VERRE 8 MM

BLOC PORTE ALU



PORTE ALU VITRÉE

Dimension	Sens d'ouverture	Réf.	PRIX
H. 2 150 x L. 930	Droite	GOL4001	119 995 F
	Gauche	GOL4003	



PORTE ALU À JALOUSIE

Dimension	Sens d'ouverture	Réf.	PRIX
H. 2 150 x L. 930	Droite	GOL4002	195 995 F
	Gauche	GOL4004	

BAIE VITRÉE COULISSANTE ALU



BAIE VITRÉE 2 VANTAUX + MOUSTIQUAIRE

Dimension	Réf.	PRIX
L. 1 600 x H. 2 150	GOL1051	129 995 F
L. 2 000 x h. 2 150	GOL1052	136 995 F



BAIE VITRÉE 3 VANTAUX + MOUSTIQUAIRE

Dimension	Réf.	PRIX
L. 2 400 x H. 2 150	3 VANTAUX - GOL1053	195 995 F
L. 3 200 x H. 2 150	2 VANTAUX + 1 JALOUSIE GOL1054	273 990 F

MENUISERIE ALUMINIUM

ÉPAISSEUR DU VERRE 8 MM



Chariots réglables à roulement à bille et roulettes polymère



- Fermeture par crochet avec anti-soulevage
- Gâches aluminium intégrées au dormant
- 2 points de fermeture



FENÊTRE À LA FRANÇAISE

Dimension	Réf.	PRIX
L. 1 000 x H. 1 000	GOL0301	66 995 F
L. 1 200 x H. 1 200	GOL0302	77 995 F



FENÊTRE 2 VANTAUX COULISSANTS+ MOUSTIQUAIRE

Dimension	Réf.	PRIX
L. 1 000 x H. 1 150	GOL3201	59 995 F
L. 1 200 x H. 1 150	GOL3202	64 995 F
L. 1 400 x H. 1 150	GOL3203	66 995 F



FENÊTRE 2 VANTAUX + JALOUSIE + MOUSTIQUAIRE

Dimension	Réf.	PRIX
L. 1 200 x H. 1 150	GOL0101	99 995 F
L. 1 800 x H. 1 150	GOL0102	129 995 F

FENÊTRE



MENUISERIE ALUMINIUM

ÉPAISSEUR DU VERRE 6 MM



Jalousie + moustiquaire
L. 400 x H. 400
Réf. GOL3102

17 995 F



Jalousie + moustiquaire
L. 600 x H. 400
Réf. GOL3106

22 995 F



Jalousie + moustiquaire
L. 600 x H. 800
Réf. GOL3110

31 995 F



Jalousie + moustiquaire
L. 600 x H. 600
Réf. GOL3108

26 990 F



Jalousie + moustiquaire
L. 400 x H. 600
Réf. GOL3104

19 995 F



Jalousie + moustiquaire
L. 800 x H. 800
Réf. GOL3114

36 995 F



Jalousie + moustiquaire
L. 1000 x H. 800
Réf. GOL3115

53 990 F

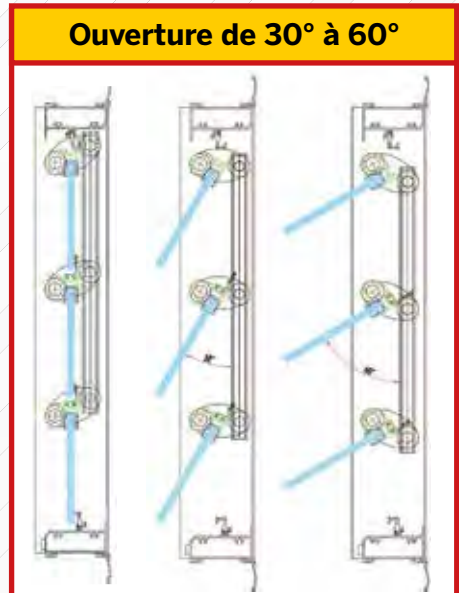

Ouverture de 30° à 60°



Moustiquaires amovibles

JALOUSIE ALU + MOUSTIQUAIRE



La conception de la fenêtre de toit à rotation GGL permet d'aménager le volume sous la baie tout en conservant l'accès à la barre de manoeuvre, pour un encombrement minimum. Une installation adaptée permet de conserver une vue vers l'extérieur en position assise ou debout. La hauteur optimale de la fenêtre dépendra de la pente du toit. Une étude préalable de l'espace et des dimensions disponibles permettra d'optimiser l'aménagement.

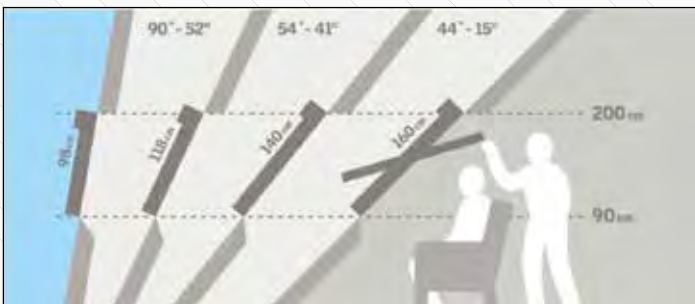

Fenêtre + raccord MK04
Velux 78 x 98 cm
 Velux GGL STD MK04 - Réf. VEL0001 - **84 000 F**
 Raccord Velux EDW MK04 Gris - Réf. VEL0100 - **15 995 F**

99 995 F l'ensemble

- PENTE DE TOIT**
15° > 90°
- ISOLATION SONORE**
- ISOLATION THERMIQUE**
- SÉCURITÉ**

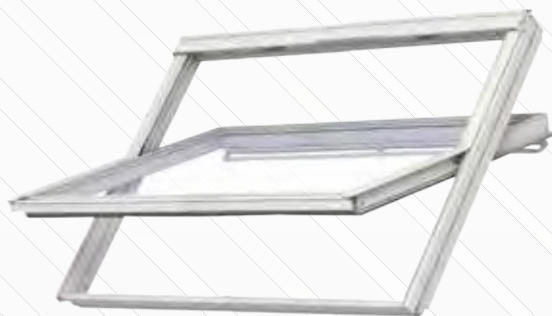

Fenêtre + raccord UK04
Velux 134 x 98 cm
 Velux GGL STD UK04 - Réf. VEL0002 - **130 000 F**
 Raccord Velux EDW UK04 Gris - Réf. VEL0101 - **19 995 F**

149 995 F l'ensemble

- PENTE DE TOIT**
15° > 90°
- ISOLATION SONORE**
- ISOLATION THERMIQUE**
- SÉCURITÉ**

STORE OCCULTANT



Beige

Bleu nuit

Dimension	Réf.	PRIX
78 x 98 cm	Beige - VEL0201	18 995 F
	Bleu nuit - VEL0203	
134 x 98 cm	Beige - VEL0202	29 995 F
	Bleu nuit - VEL0204	

FENÊTRE DE TOIT À ROTATION

ACCESSOIRE



GAMME AQUILON 55ZN - Longueur 2,50 m

**SPÉCIAL
BORD DE MER**



Panneau - Vert

Hauteur en m.	Réf.	PRIX
1,53	LIP0221	10 990 F

Poteau - Vert

Hauteur en m.	Réf.	PRIX
2	LIP0333	5 595 F

GAMME ISIS44 - MEDIUM - Longueur 2 m

PANNEAU ATLANTIS GALVANISÉ

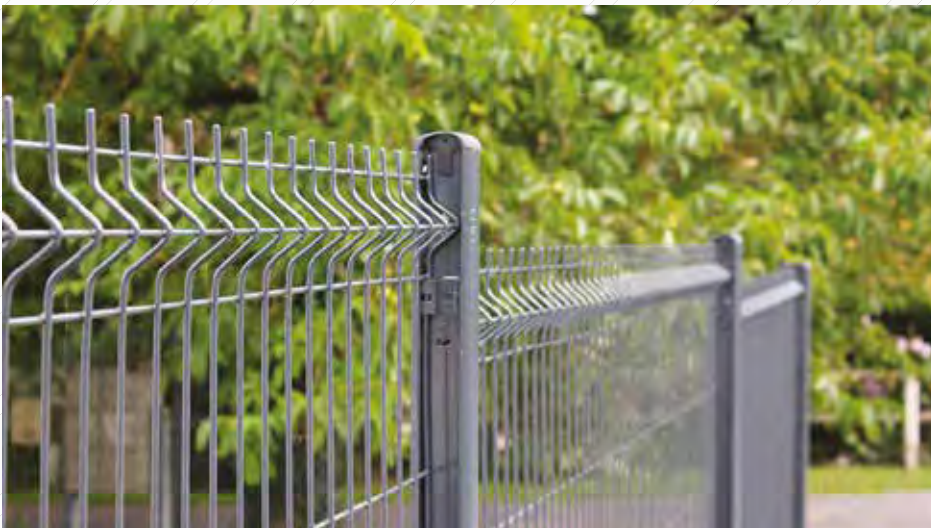

Panneau

GRAPHITE	Hauteur en m.	Réf.	PRIX
	1,42	LIP0218	4 290 F
	1,72	LIP0219	4 995 F

VERT	Hauteur en m.	Réf.	PRIX
	1,22	LIP0222	3 995 F
	1,42	LIP0223	4 795 F
1,72	LIP0224	5 295 F	

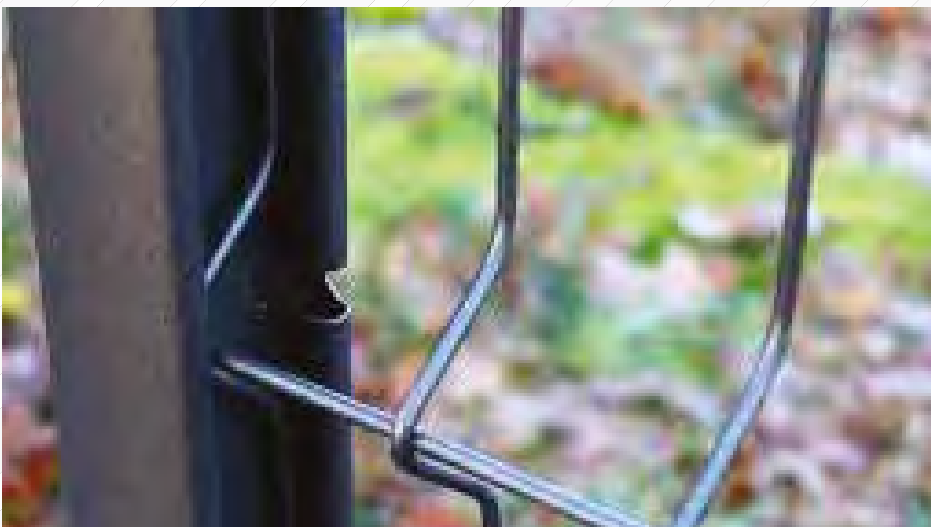

Poteau

GRAPHITE	Hauteur en m.	Réf.	PRIX
	1,70	LIP0326	3 495 F
	2,20	LIP0327	4 290 F

VERT	Hauteur en m.	Réf.	PRIX
	1,70	LIP0334	3 495 F
	2,00	LIP0335	3 995 F
2,20	LIP0336	4 295 F	



GAMME AQUILON 55 - Longueur 2,50 m



BLANC	Hauteur en m.	Réf.	PRIX
	1,23	LIP0201	6 995 F
	1,43	LIP0202	7 995 F
	1,73	LIP0203	8 995 F

VERT	Hauteur en m.	Réf.	PRIX
	1,03	LIP0220	5 995 F
	1,23	LIP0204	6 995 F
	1,53	LIP0214	8 590 F
	1,73	LIP0206	8 995 F
1,93	LIP0213	10 595 F	

FEUILLURE

POTEAU

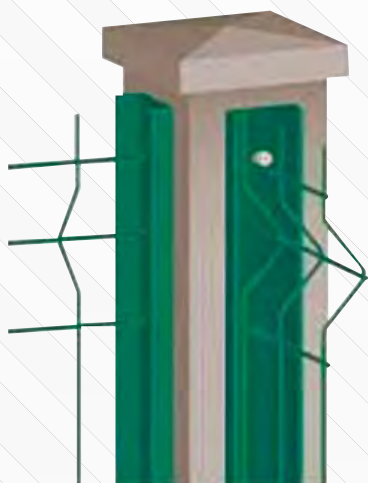

BLANC	Hauteur en m.	Réf.	PRIX
	1,75	LIP0351	3 895 F
	1,95	LIP0352	4 095 F
2,25	LIP0353	4 295 F	

BLANC	Hauteur en m.	Réf.	PRIX
	1,75	LIP0320	4 595 F
	1,95	LIP0321	4 895 F
2,25	LIP0322	5 095 F	

VERT	Hauteur en m.	Réf.	PRIX
	1,45	LIP0355	3 595 F
	1,75	LIP0356	3 895 F
	1,95	LIP0357	4 095 F
	2,25	LIP0358	4 295 F
2,50	LIP0359	4 795 F	

VERT	Hauteur en m.	Réf.	PRIX
	1,45	LIP0329	4 290 F
	1,75	LIP0323	4 595 F
	1,95	LIP0324	4 895 F
	2,25	LIP0325	5 095 F
2,50	LIP0328	5 995 F	

ÉCROUS AUTOCASSANTS ATLANTIS INOX

PORTAIL

	Réf.	PRIX
Écrous autocassants	LIP0311	295 F
Bloqueur de clips XXL	LIP0315	585 F
Clipseur	LIP0310	9995 F
Location clipseur	LIP0313	1540 F

CLIP ATLANTIS INOX



Couleur	Réf.	PRIX
Blanc	LIP0307	139 F
Vert	LIP0308	139 F



VERT	Hauteur en m.	Réf.	PRIX
	1,20	LIP0401	39 990 F
	1,50	LIP0402	41 995 F
1,75	LIP0403	42 995 F	

GAMME PREMIUM 55

ACCESSOIRE



GARDE CORPS

VERRE



Fixation au sol
Dimension 100 x 100 cm, épaisseur 8 mm
Réf. SOMV002

59 995 F



Fixation murale
Dimension 125 x 100 cm, épaisseur 8 mm
Réf. SOMV003

69 990 F

ACCESSOIRE PORTAIL AUTO-PORTANT

PORTAIL



Kit complet
Réf. IBF0221

29 890 F

ACCESSOIRE PORTAIL



Roue Ø 80
avec support,
gorge en V
Réf. IBF0129

1 495 F



Plaque de guidage
Réf. IBF0160

2 695 F



Arrêt pour portail coulissant
à souder
Réf. IBF0165

1 390 F



OUTIL À MOTEUR



Débrousailluse thermique
KASEI
25,4 CC - Réf. SOMJ415
32,6 CC - Réf. SOMJ416 - **17 995 F**
42,7 CC - Réf. SOMJ417 - **18 995 F**

À partir de 16 995 F



Débrousailluse multifonction
4 en 1
Réf. AGE5030

49 995 F



Souffleur thermique
KASEI
EB260
Réf. SOMJ420

14 995 F



Souffleur thermique à dos
51,7 cm³
EB260
Réf. AGE5045

39 995 F

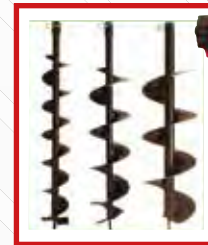

Tarière thermique
+ 3 mèches offertes
ALTRAD
51,7 cm³
Réf. ALT3001

47 995 F

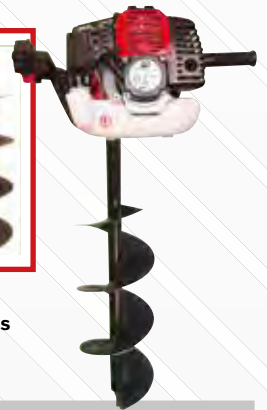

ÉLAGAGE



Taille haie électrique
FARGROOP TX750
750 W
longueur de coupe : 610 mm
Réf. FAR0201

11 990 F



Taille haie thermique
HTH250/240P
24,5 cm³
longueur de coupe : 600 mm
Réf. AGE5040

28 995 F



Tronçonneuse thermique
38 cm³
longueur de coupe : 400 mm
Réf. SOMJ207
Disponible en 450 et 500 mm

À partir de 21 990 F

OUTIL À MOTEUR



GRILLAGE GALVANISÉ

GRILLAGE SIMPLE - Torsion 25 ml



Hauteur en m.	ø fil en mm	Réf.	PRIX
1,00	1,9	LIP0031	7 795 F
1,20		LIP0028	9 695 F
1,50		LIP0029	11 990 F
1,75	2,7	LIP0010	25 695 F
2,00		LIP0011	29 995 F
2,50		LIP0012	39 990 F

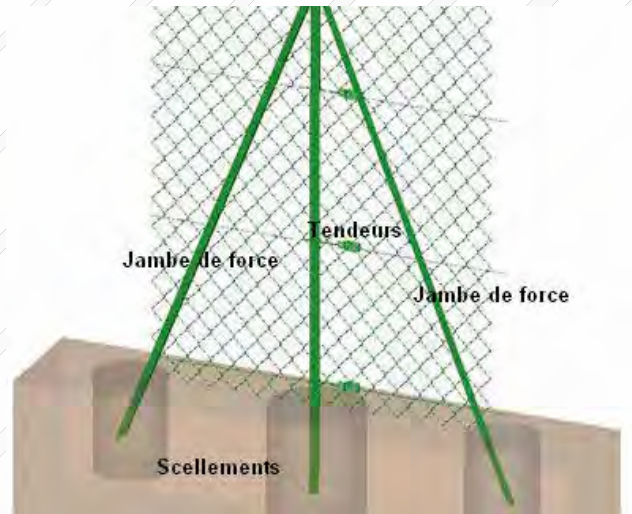

PIQUET CLÔTURE



Hauteur en m.	Réf.	PRIX
1,20	LIP0105	1 195 F
1,45	LIP0106	1 495 F
1,75	LIP0107	1 695 F
2,00	LIP0108	1 995 F
2,50	LIP0109	3 395 F
3,00	LIP0110	5 495 F

FIL TENSION



Longueur en m.	ø fil en mm	Réf.	PRIX
100	2,7	FIL0023	3 805 F
100	2,2	FIL0024	2 725 F
25	2,2	FIL0025	1 220 F
50	2,2	FIL0026	1 665 F
25	2,7	FIL0027	1 615 F
50	2,7	FIL0028	2 305 F

JAMBE DE FORCE



Hauteur en m.	Réf.	PRIX
1,20	LIP0116	995 F
1,50	LIP0117	1 295 F
1,75	LIP0118	1 395 F

BOBINOT



Longueur en m.	ø fil en mm	Réf.	PRIX
100	0,7	FIL0013	995 F
50	0,9	FIL0014	849 F
50	1,10	FIL0015	930 F
50	1,30	FIL0016	1 095 F
50	1,50	FIL0012	1 320 F

BARRE DE TENSION

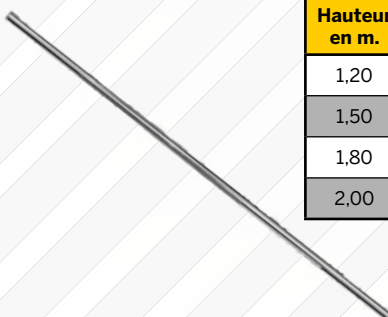

Hauteur en m.	Réf.	PRIX
1,20	LIP0125	390 F
1,50	LIP0126	495 F
1,80	LIP0127	595 F
2,00	LIP0128	650 F

RAIDISSEUR



N°	Réf.	PRIX
2	FIL0008	160 F
3	FIL0009	190 F

ACCESSOIRES GRILLAGE GALVANISÉ

GRILLAGE SIMPLE TORSION 25 ml



Hauteur en m.	ø fil en mm	Réf.	PRIX
1,00	2,4	LIP0004	8 295 F
1,20		LIP0005	9 995 F
1,50		LIP0006	12 295 F
1,75		LIP0007	14 890 F



PINCE À GRILLAGE



Unités	type agrafes	Réf.	PRIX
Manuelle	16 / 20 / 22	FIL0007	3 255 F

PIQUET CLÔTURE

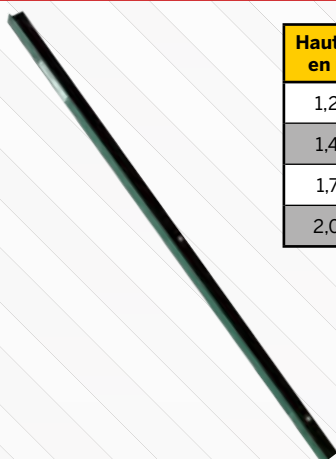

Hauteur en m.	Réf.	PRIX
1,20	LIP0101	890 F
1,45	LIP0102	1 195 F
1,75	LIP0103	1 295 F
2,00	LIP0104	1 495 F

FIL TENSION



Longueur en m.	ø fil en mm	Réf.	PRIX
100	2,75	FIL0029	2 770 F
25	2,4	FIL0030	1 190 F
25	2	FIL0031	1 210 F
50	2,4	FIL0032	1 420 F
50	2,75	FIL0033	2 130 F



JAMBE DE FORCE



Hauteur en m.	Réf.	PRIX
1,20	LIP0111	695 F
1,50	LIP0112	890 F
1,75	LIP0113	995 F
2,00	LIP0114	1 095 F
2,25	LIP0115	1 395 F

BOBINOT



Longueur en m.	ø fil en mm	Réf.	PRIX
50	0,95	FIL0019	690 F
50	1,15	FIL0020	825 F
50	1,35	FIL0021	1 065 F
50	1,60	FIL0022	1 195 F

BARRE DE TENSION

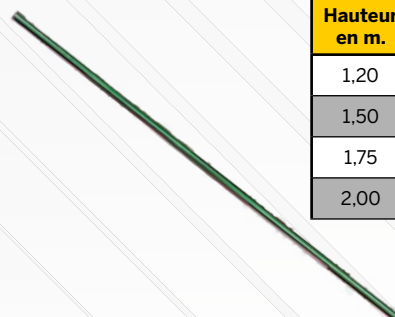

Hauteur en m.	Réf.	PRIX
1,20	LIP0121	355 F
1,50	LIP0122	435 F
1,75	LIP0123	550 F
2,00	LIP0124	595 F

RAIDISSEUR



N°	Réf.	PRIX
2	FIL0010	165 F
3	FIL0011	210 F



GRILLAGE JARDIN

GRILLAGE ARCADE 25 m



Hauteur en m.	Réf.	PRIX
0,65	LIP0001	10 990 F
0,90	LIP0002	16 995 F
1,20	LIP0003	20 995 F



GRILLAGE MAILLE HEXAGONALE

GRILLAGE POULAILLER 50 m



MAILLE FINE	Hauteur en m.	Réf.	PRIX
	1,00	LIP0036	13 995 F

MAILLE MOYENNE	Hauteur en m.	Réf.	PRIX
	1,00	LIP0037	12 995 F
	1,50	LIP0040	17 995 F
	2,00	LIP0041	23 995 F



Conçu pour réaliser des enclos tels que volières, poulaillers ou basse-cours.

AUTRES

GRILLAGE ECOPLAST VERT 20 m



Hauteur en m.	Réf.	PRIX
1,20	LIP0035	9 995 F
1,50	LIP0034	12 595 F



*La rigidité du grillage est assurée par la soudure des fils.
Traité par galvanisation et plastification standard vert (RAL 6005).*

GRILLAGE MAILLE CARRÉE 25 m



Idéal pour la fabrication de cages pour petits animaux ou nasses à poissons ou crustacés.

Hauteur en m.	Maille en mm	Réf.	PRIX
1,00	13 x 13	LIP0013	12 595 F
1,00	25 x 25	LIP0033	21 595 F

RONCE



Métal	ø fil en mm	Infos	Longueur en m	PRIX
Galva	2,7	4 picos tous les 10 cm	200	9 995 F
Zinc	1,7	4 picos tous les 13 cm	250	5 995 F

CRAMPILLON



Taille en mm	Type	Lot de	Réf.	PRIX
3 x 30	Lisse	1 Kg	LEV4011	995 F
3 x 30	Galva	1 Kg	LEV4012	1 275 F
4,5 x 40	Galva	1 Kg	LEV4013	1 295 F
4,5 x 45	Cranté	1 Kg	LEV4014	4 975 F

GABION



Métal	Taille en m	ø fil en mm	Maille en mm	Réf.	PRIX
Galva	2 x 1 x 1	2,7	80 x 100	GABION1	11 990 F
Galva	4 x 1 x 1	2,7	80 x 100	GABION2	28 995 F

GRILLAGE GUNITAGE



Métal	Taille en m	ø fil en mm	Réf.	PRIX
Galva	2 x 25	2,2	SOMJ009	21 795 F

OMBRIÈRE

Désignation	Réf.	PRIX au mètre linéaire
Ombreage 78% - vert	EMIO003	625 F
Ombreage 81% - vert	EMIO007	1 196 F
Ombreage noir 70%	EMIO013	935 F
Ombreage noir 75%	EMIO020	1 145 F

Largeur de 2 mètres

PINCE À GRILLAGE



Unités	Pour agrafes	Réf.	PRIX
Automatique	22	FIL0006	6 995 F

AGRAFES GALVA



Type	Unités	Infos	Réf.	PRIX
Galva	215	5 - 11 mm	FIL0002	775 F
Galva	400	3 - 4 mm	FIL0004	900 F
Vert	250	5 - 11 mm	FIL0005	1 245 F
Vert	1000	20 - 22 mm	FIL0001	3 835 F

AUTRES



04

S.A.V.

- La mise en marche
- L'entretien
- La réparation

Toujours là pour diagnostiquer et réparer au plus vite...

01

DEVIS GRATUIT

Pour vos travaux, le devis est gratuit.

SATISFAIT OU REMBOURSÉ

Nous remboursons intégralement un article neuf non utilisé, en parfait état de vente et dans son emballage d'origine, dans les 48h qui suivent l'achat, sur présentation du ticket de caisse.

02

SERVICE MENUISERIE

Nous nous adaptons à vos mesures...

Nous posons vos serrures et paumelles.

Voir tarifs en magasin.

03

LIVRAISON

Tout s'emporte, tout se livre !
À vous de décider...
Voir conditions en magasin.



Prix en TTC et sous réserve d'erreur typographique - Photos : D.R.

PAPEETE

Vallée de Titioro
Tél. : 40 501 950
Fax : 40 426 037
somac@somac.pf

Ouvert du lundi au vendredi
de 7h à 16h en journée continue
et le samedi de 7h30 à 11h

SOMAC

MATÉRIAUX DE CONSTRUCTION

consultez le catalogue sur le site web somac.pf

RAIATEA

Z.I. de Tahina
Uturoa

Tél. : 40 600 600
Fax : 40 662 626

contact@somacraiatea.pf

Ouvert du lundi au vendredi
de 7h30 à 12h et de 13h à 16h
et le samedi de 8h à 11h30